

# OWNER'S MANUAL



AQUATIC SYSTEMS®



For the Installation, Operation and Service of the

# EasyTouch®

EasyTouch® PNP 5  
& EasyTouch® PNP 10  
Pool and Spa Control Systems

Should the installer or owner be unfamiliar with the correct installation or operation of this type of equipment you should contact the distributor/manufacture for the correct advice before proceeding with the installation or operation of this product. The pump operator or owner must be provided with this owner's manual.

# Notices and Warnings

## Notices and Warnings

### Important Notice

This manual provides installation and operation instructions for the product. Consult Pentair with any questions regarding this product.

### Attention Installer:

This manual contains important information about the installation, operation and safe use of this product. Leave this manual with the owner and/or operator of this product after installation.

### Attention User:

This manual contains important information that will help you in operating and maintaining this product. Please retain it for future reference.



### WARNING

Before installing this product, read and follow all safety warning notices and instructions which are included. Failure to follow safety warnings and instructions can result in severe injury, death, or property damage. Call 1300-137-344 for additional free copies of these instructions.

## Read and Follow all Safety Instructions

This product is designed and manufactured for safe and reliable service when installed, operated and maintained according to the information and installation codes referred to in this manual.

 This is a safety alert symbol. When you see this symbol in this manual or on the product, look for one of the following signal words; DANGER, WARNING, CAUTION and NOTICE and comply with the information. Be alert to the potential hazard. Ensure to read and comply with all of the warnings and cautions in this manual.



### DANGER

#### **Risk of Electrical Shock or Electrocutation!**

This product must be installed by a licensed electrician. Installations must comply with:

- The Wiring Rules AS/NZS 3000.
- All applicable local codes and ordinances.
- Always disconnect power at the circuit breaker before servicing the load centre. Failure to do so could result in death or serious injury to installer, service person, pool users, or others due to electrical shock.
- Improper installation can create an electrical shock hazard that can result in death or serious injury.



### WARNING

Water temperature in excess of 38 degrees Celsius may be hazardous to your health. Prolonged immersion in hot water may induce hyperthermia. Hyperthermia occurs when the internal temperature of the body reaches a level several degrees above normal body temperature of 37°C. The symptoms of hyperthermia include drowsiness, lethargy, dizziness, fainting, and an increase in the internal temperature of the body.

The effects of hyperthermia include: 1) Unawareness of impending danger. 2) Failure to perceive heat. 3) Failure to recognize the need to leave the spa. 4) Physical inability to exit the spa. 5) Foetal damage in pregnant women. 6) Unconsciousness resulting in danger of drowning.



### WARNING

To reduce the risk of injury, do not permit children to use this product unless they are closely supervised at all times.



### WARNING

The use of alcohol, drugs, or medication can greatly increase the risk of fatal hyperthermia in hot tubs and spas.

## Notices and Warnings (Continued)

**WARNING**

Control System is intended to control heaters with built-in high limit circuits ONLY. Failure to do so may cause property damage or personal injury.

**WARNING**

Do not use this product to control an automatic pool cover. Swimmers may become entrapped underneath the cover.

**WARNING**

For units intended for use in other than single-family dwellings, a clearly labelled emergency switch shall be provided as part of the installation. The switch shall be readily accessible to the occupants and shall be installed at least 3m away, adjacent to, and within sight of, the unit.

**WARNING**

This appliance is not intended for use by persons (including children) with reduced physical, sensory or mental capabilities, or lack of experience and knowledge, unless they have been given supervision or instruction concerning the use of the appliance by a person responsible for their safety. Please ensure that young children are supervised to ensure that they do not play with the appliance.

## General Installation Information

1. All work must be performed by a licensed electrician, and must conform to all national, state, and local codes.
2. Installer to provide drainage of compartment for electrical components.
3. Power to all circuits must be supplied via a suitably sized Residual Current Device (RCD) in the fixed wiring.
4. An Earth terminal bar is located inside the supply terminal box. To reduce the risk of electric shock, this terminal must be connected to the grounding means provided in the electric supply service panel with a continuous copper wire equivalent in size to the circuit conductors supplying this equipment and as per the wiring rules.
5. The electrical supply for this product must include a suitably rated switch or circuit breaker to open all ungrounded supply conductors to comply with the Wiring Rules. The disconnecting means must be readily accessible to the occupant.
6. Supply conductor must be sized to support all loads. Maximum supply conductor current is 125 Amps at 230-240VAC.

# Contents and Accessories

## EasyTouch Contents and Accessories

### EasyTouch® Pool and Spa Control System Kit Contents

- EasyTouch control panel (mounted in the load centre).
- EasyTouch load centre enclosure.
- Water sensor with 8m cable, o-ring and hose clamp.
- Air sensor with 2m cable.
- EasyTouch Pool and spa Control System Installation Guide (this manual).

### EasyTouch® Accessories (Sold Separately)

		
<p>EasyTouch Indoor Control Panel (P/N 520548 4-Circuit) (P/N 520549 8-Circuit)</p>	<p>EasyTouch Wireless Control Panel (P/N 520546 4-Circuit) (P/N 520547 8-Circuit)</p>	<p>Wireless connection kit (P/N 520639)</p>
		
<p>SpaCommand Spa Side Remote (P/N 521178)</p>	<p>iS4 Spa-Side Remote Controller (P/N 521887)</p>	<p>QuickTouch® II wireless remote controller (P/N 521209-AU)</p>
		
<p>ScreenLogic® Interface for PC/ Mac and mobile devices. (P/N 520500-AU)</p>	<p>Valve Actuator (P/N 263045)</p>	<p>IntelliValve Digital Valve Actuator (P/N 521485)</p>

## Table of Contents

<b>Hydraulic Set-Up</b>	<b>6</b>
Plumbing Requirements	6
System Schematic	7
<b>Electrical Installation</b>	<b>8</b>
EasyTouch Load Centre High Voltage Connections	8
EasyTouch Load Centre Location	8
Preparing the EasyTouch Load Centre Enclosure	9
Mounting the EasyTouch Load Centre	10
Installing Conduit and Wire to the EasyTouch Load Centre	11
Relay Wiring	12
Relay Wiring Schematic	13
EasyTouch Motherboard Connections	14
Accessing the EasyTouch Motherboard	15
Installing Valve Actuators	16
Installing and Connecting Temperature Sensors	17
Connecting the Gas Heater or Heat Pump	18
Pool/Spa Heating Combinations (Recommended Configurations)	18
EasyTouch System Start-Up	19
EasyTouch System Wiring Diagram	20
EasyTouch® Control System Outdoor Control Panel	21
EasyTouch Indoor Control and Wireless Control Panel (Optional)	24
EasyTouch Menus	25
<b>Programming EasyTouch (Step By Step)</b>	<b>26</b>
Set the System Date and Time	27
Settings Menu: English / Metric (Fahrenheit/Celsius)	27
Circuit Names	28
EasyTouch Circuit Names	29
Settings Menu: Custom Names	29
Circuit Functions	30
Freeze Protection	30
Heat Menu	32
Solar	33
IntelliFlo® Menu	34
IntelliFlo VF Pump Settings	35
Schedules Menu	38
iS4 Spa-Side Remote Controller	42
SpaCommand 10 Button Spa-Side Remote Controller	42
10 Button Pump Cntrl	43
QuickTouch (QT4) Wireless Remote	44
<b>Advanced Settings</b>	<b>45</b>
Setting up lights	45
Setting up IntelliBrite Light Circuits	45
Setting up MagicStream Laminars	48
Delays	50
Heat Pump COM (UltraTemp® Heat Pump)	50
IntelliChlor	51
Salt Chlorinator Connection (Other than IntelliChlor)	51
IntelliChem®	52
Settings Menu: 2-Speed Pump	53
Man Heat (Off/On)	54
Calibration	54
Erase EEPROM (Erase System Memory)	55
Set Password	55
Wireless Addr	56
Synchronizing control panels	57
Spa Side [Off/On]	58
Diagnostics Menu	58

## Hydraulic Set-Up

### Plumbing Requirements

It is important that the pool and spa plumbing system be in accordance with local codes and the Recommended Hydraulic Schematics (page 7). Before starting, please review the diagrams and the following recommended guidelines:

1. The spa should be at or above the level of the pool. If the spa is attached to the pool, provide a dam between the two bodies of water to allow the spa to overflow into the pool. If the spa is not attached to the pool, an overflow, sufficient in size to carry a full pump-flow, must be installed at the water level in the spa.
2. Plumb a three-port Intake Valve on the suction-side of the filter pump, so that the centre port of the valve is connected to the pump inlet. Connect the spa suction to one side of the Intake Valve, and the pool suction to the other side.
3. Plumb a three-port Return Valve on the return-side of the heater, so that the return water will enter the valve through the centre port. Connect the spa return to one side of Return Valve, and the pool return to the other side.
4. If required, install a spa makeup line (consisting of a manual gate or ball valve, for elevated spas install a check valve) to bypass the pool return line. This will enable some of the chemically balanced water from the pool to cycle through the spa. The manual valve will allow the amount of bypass to be adjusted.
5. If the spa is to be constructed in concrete, special provision should be made at this time for the installation of the Spa-Side remote control. Select a convenient location in the deck or above water level in the spa wall (where the Spa-Side remote will not be submerged by the spa water), and install a 15 to 30cm length of 25mm PVC pipe to provide a receptacle for the Spa-Side remote. The pipe should be level and protrude beyond the finished surface of the spa. It will be cut back later at installation time. Reduce the pipe size down to 12mm or 20mm conduit, and run it to the proposed Load/Power Centre location at the equipment pad. Use sweep elbows for turns. The Spa-Side remote will not be installed until the spa construction is completed.
6. For systems which incorporate a skimmer, it is possible to balance the amount of suction between the skimmer and main drain for maintenance purposes. This is easily accomplished by installing a manual three-port mixing valve at the suction line. Plumb one port to the skimmer and the other to the main drain.
7. If a "non-booster pump" pressure-side pool cleaner is being used, plumb a manual three-port valve between the filter pump and filter, with the third port plumbed to the pool cleaner line, and install a motorized two-port Pool Cleaner Valve at this line. The motorized valve will automatically open whenever the Control System activates the pool cleaner.
8. If a booster pump pool cleaner is being used, plumb the booster pump so that its suction-side is connected to the pool return, after the heater, and as close to the ground as practical.
9. Plumb the solar feed and return lines between the filter and the heater. Install a three-port valve at the feed line. Use a solar valve (model SOL-2T), to allow automatic draining of the panels.
10. A solar booster pump should be used when the distance to the panels exceed 70m, or the panels are elevated higher than 10m.
11. Glazed solar panels require a drain valve to allow draining of the panels. This prevents damage from overheating water. Install a drain valve at the solar feed line and connect to the pool fill line.
12. Salt chlorinators should be installed after the gas heater and all other equipment with a check valve before to prevent back flow of highly concentrated chlorine into equipment.

## System Schematic

All equipment should be installed in an appropriate pool zone, depending on IP rating as per the Wiring Rules AS/NZS 3000.

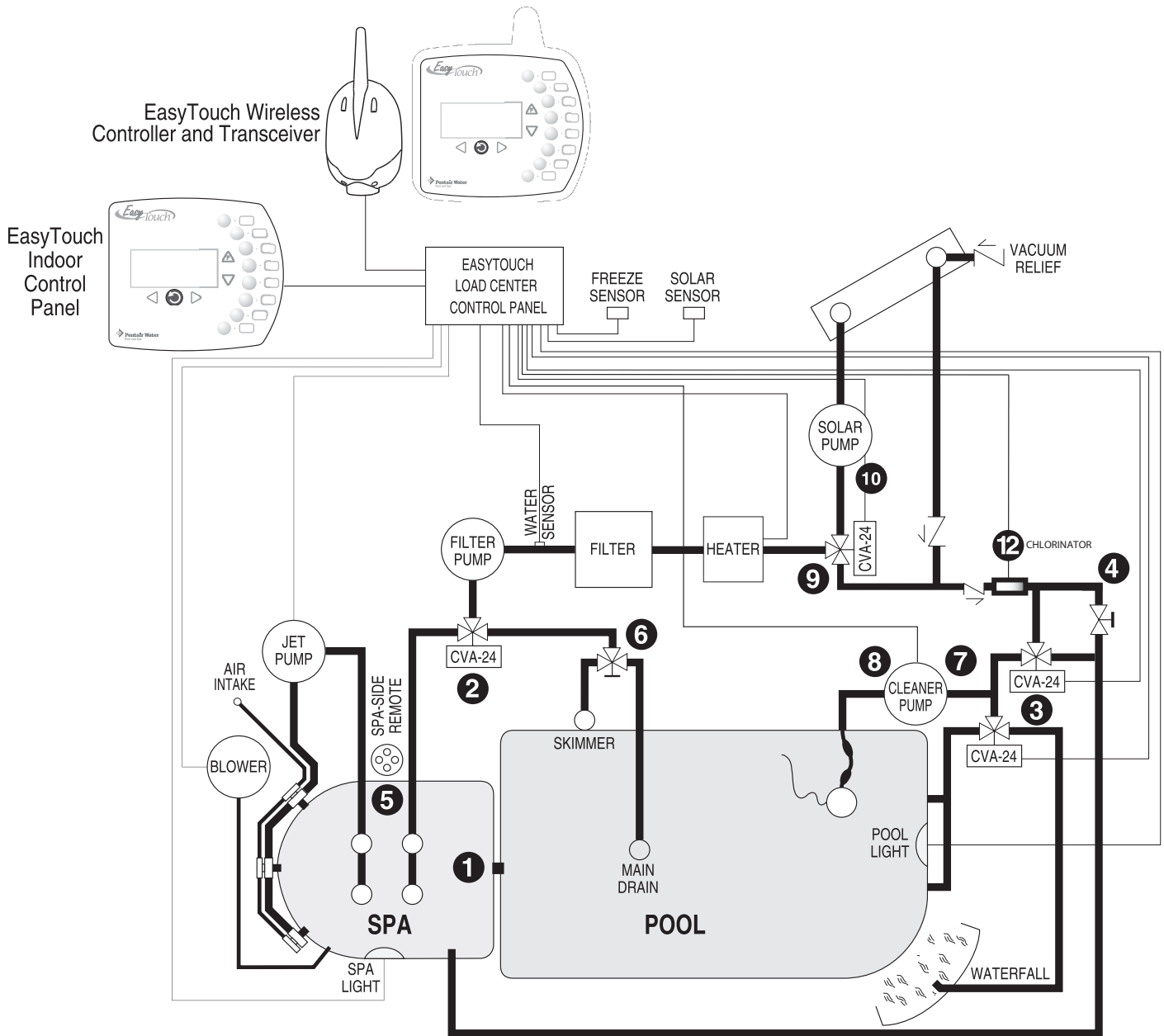

Recommended Hydraulic Schematic for Shared Equipment System

## Electrical Installation

### EasyTouch Load Centre High Voltage Connections

The EasyTouch load centre enclosure includes Active, Neutral and Earth bus terminals, pre-wired power relays, electrical outlets and control system transformer.



#### **WARNING**

#### **BEFORE REMOVING THE HIGH VOLTAGE COVER PANEL FROM THE ENCLOSURE**

switch the main power OFF into the home at the main circuit breaker box. Also, switch OFF the main power to the EasyTouch load centre before removing the high voltage cover panel to access the low voltage raceway.

### EasyTouch Load Centre Location

Before installing the EasyTouch load centre read the following guidelines:

- AC power for the EasyTouch load centre must be provided from the main circuit breaker panel located at the house.
- All electrical equipment, except for low voltage purpose made spa-side remote switches, must be installed at appropriate distance from pool and/or spa, and comply with the Wiring Rules.
- Install the EasyTouch load centre in appropriate zone (AS/NZS 3000) away from pool/spa near to the pumps, heater, valves, and sensors. Mount the enclosure outside under eaves or inside a pool equipment house or other enclosure.
- Before choosing the final location for the EasyTouch load centre, consider the length of the power cables and other wires that have to be connected to the enclosure. Make sure to consider cable lengths for the sensors to the EasyTouch load centre location. The Air Temperature Sensor cable is 1m long and the Water Temperature Sensor is 8m long. Most appliance power cables are 2m long.
- DO NOT use extension cords between the EasyTouch load centre and connected equipment unless the extension cord is designed for use in wet environments and certified to the applicable AS/NZS standard.
- Mount the EasyTouch load centre on a flat vertical surface or wall so that the electrical outlets are located at the bottom of the enclosure. Upper and lower brackets are provided to mount the enclosure to a vertical surface.
- DO NOT mount the EasyTouch load centre enclosure horizontally. Water can enter the enclosure and cause damage to the system and an electrical shock hazard.
- Consider the EasyTouch load centre location when routing the conduit carrying the AC power to the EasyTouch load centre.
- Install the EasyTouch load centre so that drainage is provided for all electrical components.
- All electrical appliances should be compliant to Australian/New Zealand Standards.
- Allow for unobstructed access to the front of the EasyTouch load centre for the owner or service personnel.
- The EasyTouch load centre provides grounding screw terminals for grounding all equipment. All equipment including the EasyTouch load centre enclosure must be bonded to earth ground.



## Preparing the EasyTouch Load Centre Enclosure

Before mounting the EasyTouch load centre, first remove the front door and the high voltage panel to access the electrical connections and low voltage raceway.

To remove the EasyTouch load centre front door and high voltage panel

1. Unpack the load centre from the shipping box.
2. Unlatch the front door spring latches, and open the front door.
3. Remove the front door from the hinges.
4. Remove the screws securing the high voltage cover-panel. Remove the cover-panel from the enclosure.
5. Proceed with:
  - Mounting the EasyTouch Load Centre, page 10
  - Installing Conduit and Wire to the EasyTouch Load Centre, page 11
  - EasyTouch Motherboard Connections, page 14
  - Accessing the EasyTouch motherboard, page 15
6. After electrical connections have been completed, reinstall the enclosure door on its hinges and install the door release screw. Reinstall the high voltage panel and secure with the retaining screws.

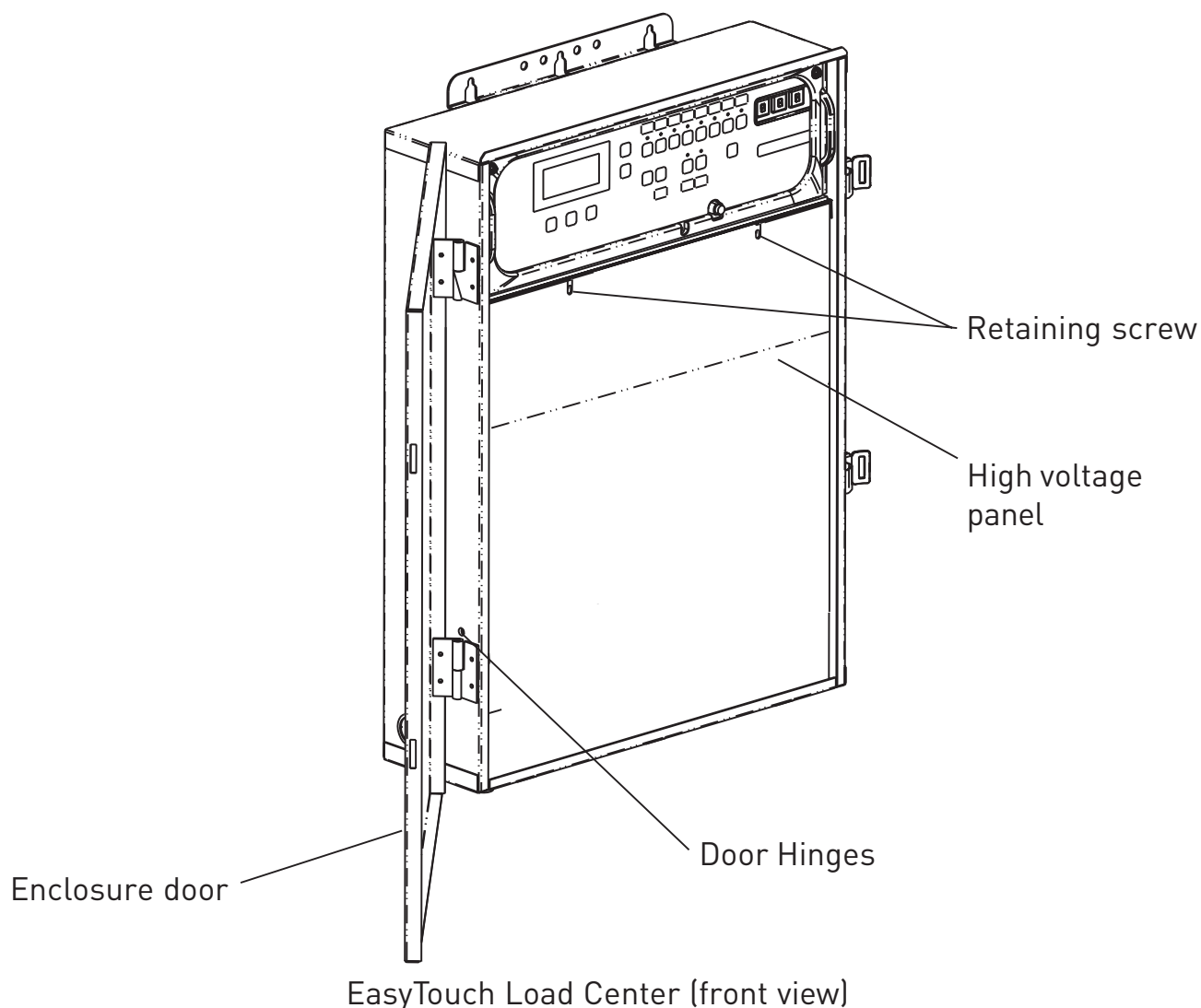

# Electrical Installation

## Mounting the EasyTouch Load Centre

The EasyTouch load centre can be mounted on a flat vertical surface, such as a wall or post.

To mount the EasyTouch load centre:

1. Position the EasyTouch load centre against the vertical flat surface. If wall anchors are being used, support the EasyTouch load centre enclosure in position (horizontally level and square) against the surface and mark the bracket hole pattern on the wall.
2. Secure the enclosure with three (3) screws in the top and lower mounting bracket holes. If using wall anchors, drill and set the anchors and secure the enclosure with screws.

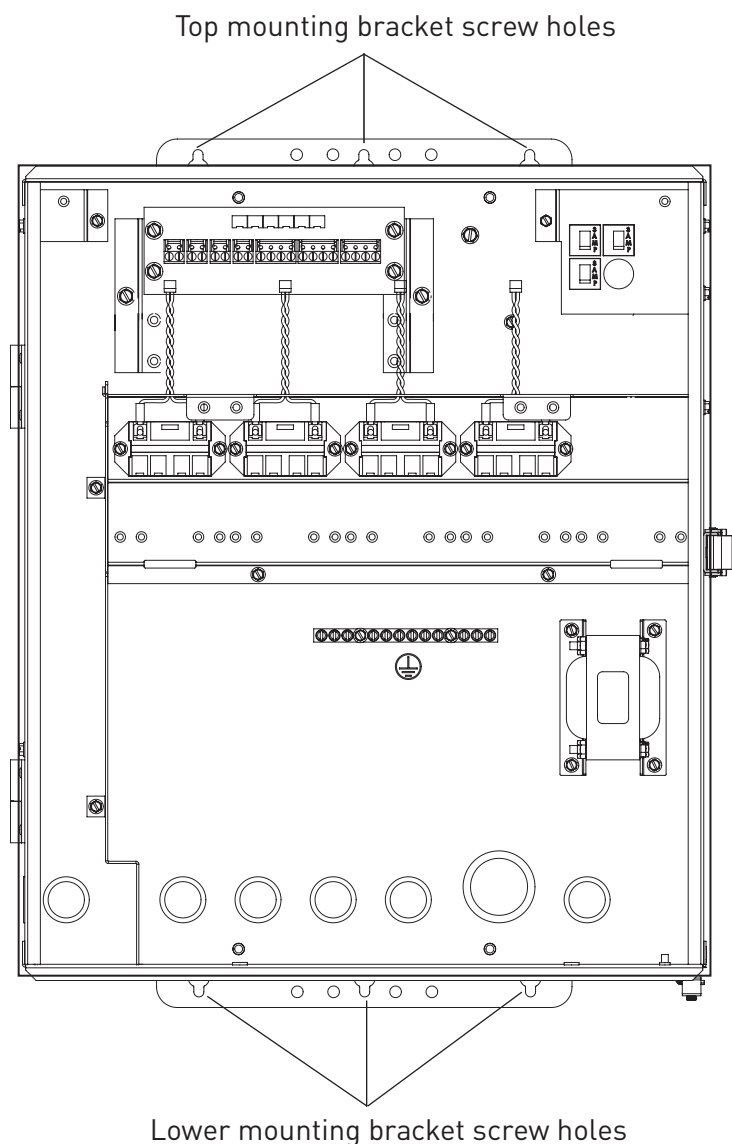

EasyTouch Load Center (front view)  
(front door and high voltage panel removed)

## Installing Conduit and Wire to the EasyTouch Load Centre

Before installing electrical conduit, read the following recommended guidelines:

- Determine the number of low and high voltage circuits being used in the EasyTouch load centre.
- Determine the appropriate number of RCD's (Residual Current Devices) required to provide protection to each outlet connected to the EasyTouch load centre. RCD's may be able to be shared across circuits depending on load and in accordance with the Wiring Rules AS/NZS 3000. RCD's should be located in the house's main circuit board or a separate sub-panel.
- Separate conductors should be run for each RCD between the circuit board and the EasyTouch Load centre. Use a 25mm conduit for these power supply conductors.
- Connect supply conductors to associated circuits using the active and neutral terminal blocks in the load centre.
- Use minimum 1.5mm<sup>2</sup> for relay circuits connections inside the load centre. Be sure to follow all regulation safety codes for the number and size of conductors that can be installed in various sizes of conduit.
- To avoid obstruction into the EasyTouch load centre, when using electrical conduit complete the installation of the conduit before concrete is poured. Also, underground conduit should be positioned in well compacted soil. Ensure that all conduit joints are well sealed and watertight.

To install electrical conduit and wires as needed:



### WARNING

**TO AVOID AN ELECTRICAL HAZARD** - Do not connect the power source conductors to the EasyTouch load centre until all electrical connections for all loads (heaters, pumps, motorized valves, and lights etc.) have been completed.

- Use the one of the four low voltage raceway 20mm holes located on the underside of the enclosure for the temperature sensor wires.
- The maximum rated load for the EasyTouch load centre is 125 AMP at 230/240 VAC 50 Hz.



### CAUTION

All of the electrical wiring methods and materials used to complete the electrical installation of the EasyTouch Pool/Spa Control System must be in accordance with the Wiring Rules AS/NZS 3000, as well as any local electrical codes in effect at the time of installation.



### CAUTION

All electrical materials used for the EasyTouch installation must be accomplished by, or be under the direct supervision of a qualified electrician.

# Electrical Installation

## Relay Wiring

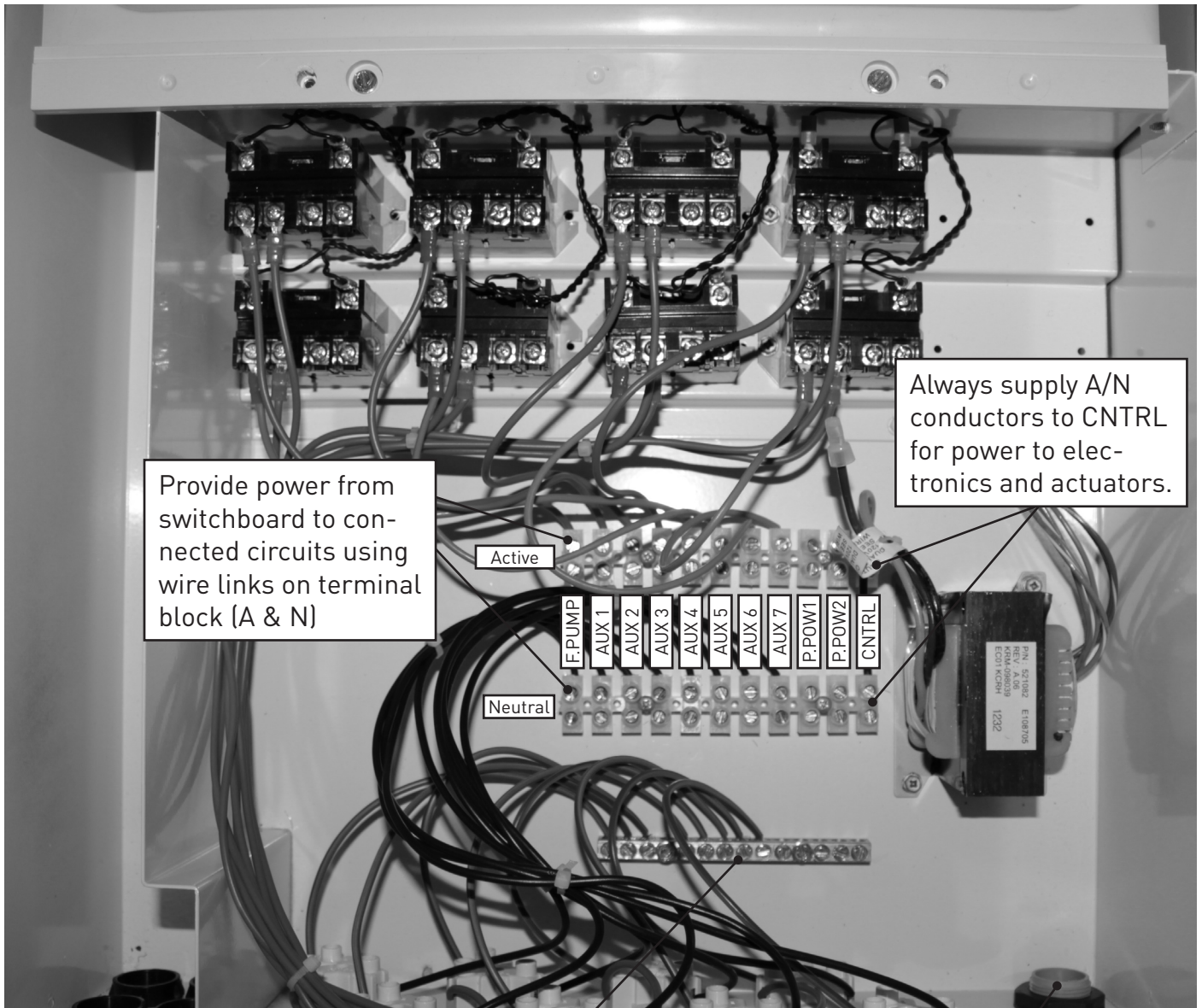

Provide power from switchboard to connected circuits using wire links on terminal block (A & N)

Always supply A/N conductors to CNTRL for power to electronics and actuators.

Active

Neutral

Earth Bar - Connect to Supply Earth (always) and Equipotential Bonding of Pool (if applicable)

25mm Conduit Connection (Supply Conductor Entry Point)

Relay Wiring Schematic

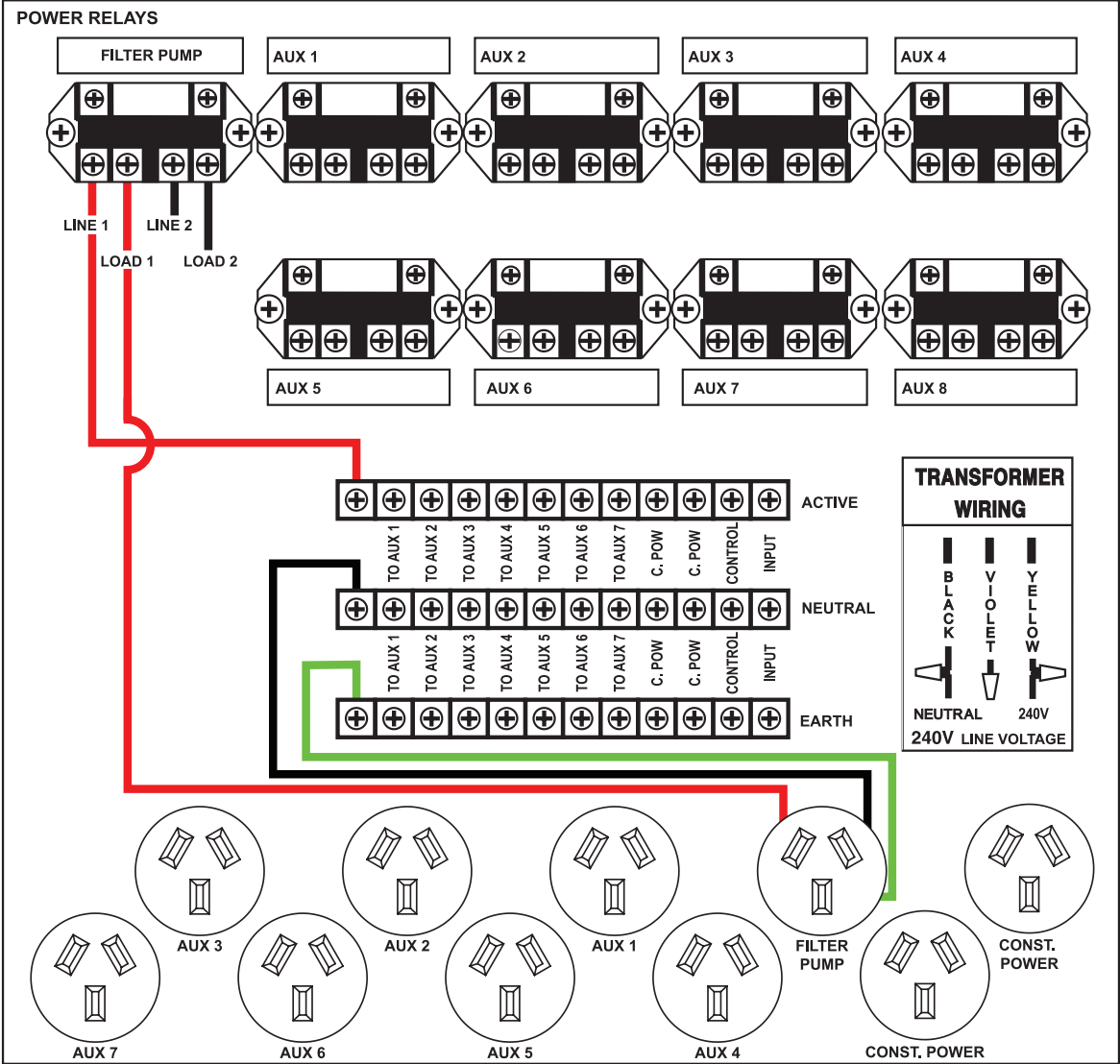

# Electrical Installation

## EasyTouch Motherboard Connections

The EasyTouch system motherboard is mounted onto the back of the main load centre control panel. The motherboard provides the voltage connections to switch the filter pump, heater, auxiliary relays, motorized valves, and connections for temperature sensors, EasyTouch Indoor Control Panel and iS4 Spa Side remote. To access the motherboard, refer to "Accessing the EasyTouch Motherboard," on page 15.

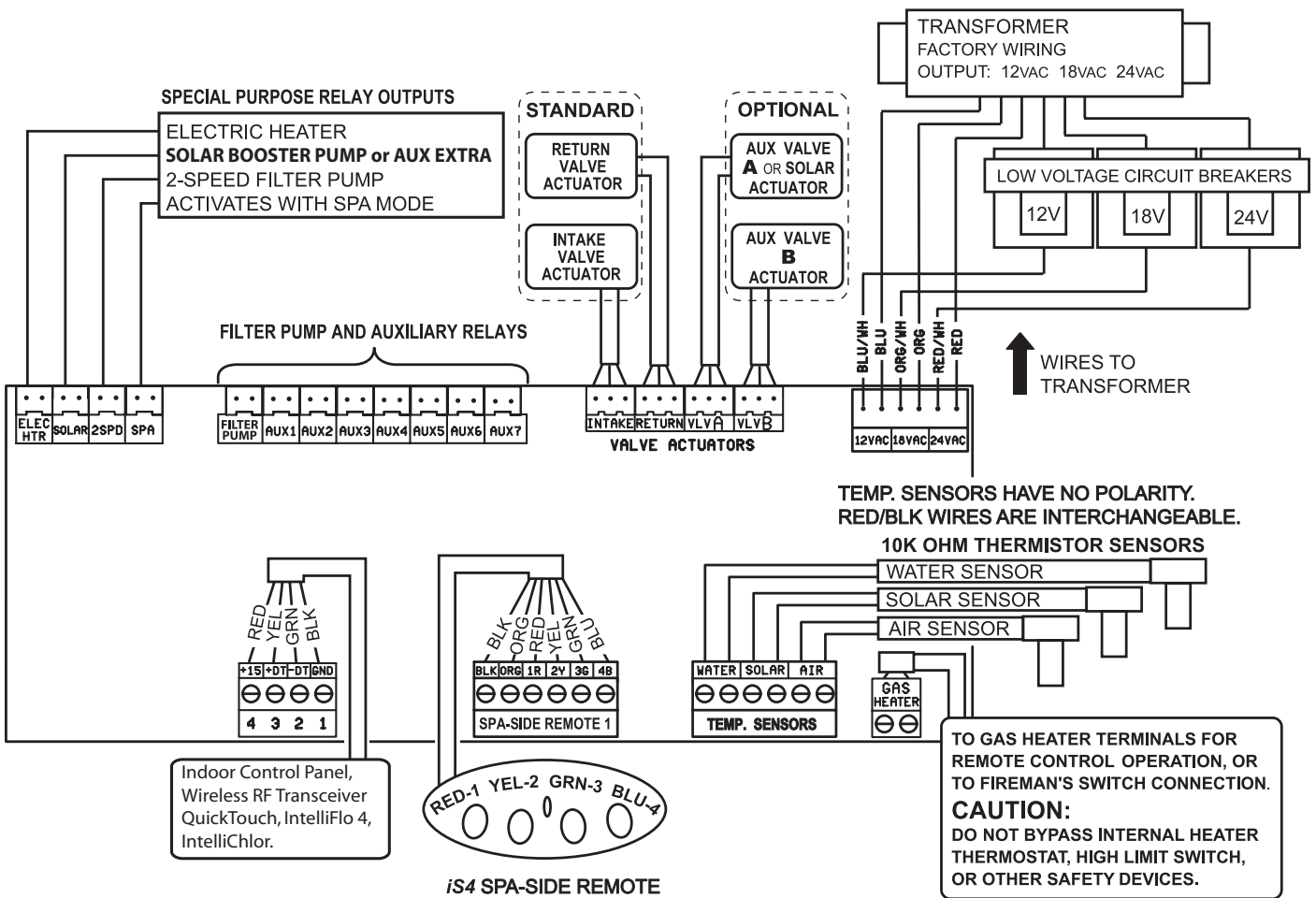

EasyTouch Motherboard Connections

## Accessing the EasyTouch Motherboard

The EasyTouch motherboard provides connectors for the auxiliary relays, valve actuators and sensors. To access the motherboard connectors, fold down the main control panel.

To access the motherboard connectors:

1. Loosen the two retaining screws securing from the top edge of the control panel.
2. Fold down the control panel to access the rear of the motherboard for the electrical connections.
3. Proceed with:
  - Installing the Valve Actuator, page 16
  - Installing and Connecting Temperature Sensors, page 17
  - Connecting the Heater, page 18
4. After electrical connections have been completed, close the control panel and tighten the two retaining screws.

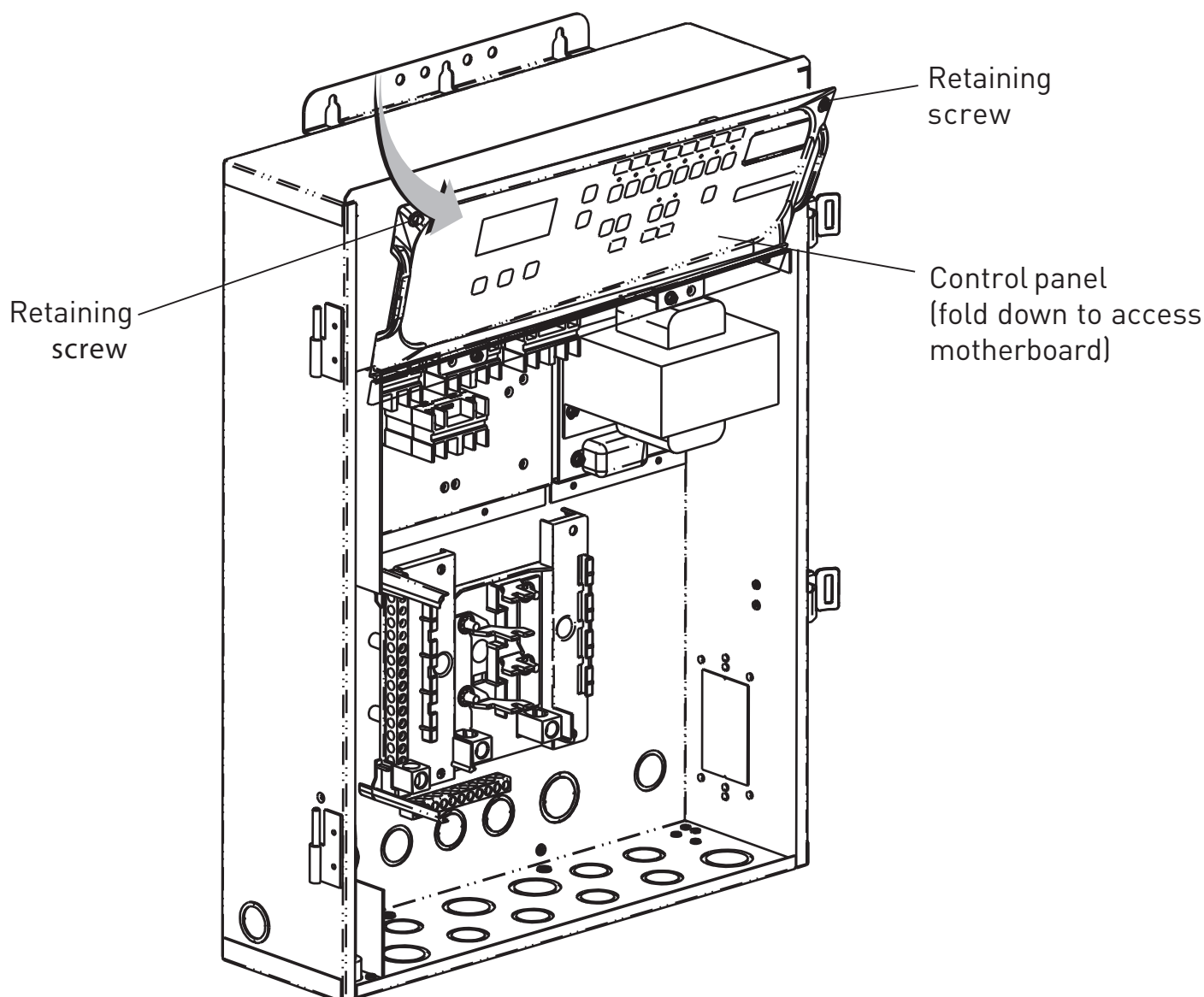

# Electrical Installation

## Installing Valve Actuators

For shared equipment systems there are two motorized valve actuators (CVA-24T, P/N 263045). To install the valve actuators:

1. Remove the valve knob, handle and the four screws, from the valve cover (indicated with arrows).
2. Align the splines of the actuator shaft over the shaft of the valve.
3. If the actuator is not aligned with the mounting holes on the valve cover, rotate the actuator (while still attached to the valve) until the actuator is positioned correctly over the valve.
4. Secure the actuator with the screws provided. Only use self-tapping screws when required.
5. Mount the valve handle and knob onto the actuator.
6. At the Load Centre, route the cable up through the 1" grommet and low voltage raceway to Personality board.
7. Connect the Valve A actuator cable plug into the INTAKE (suction) 3-pin socket, and Valve B actuator cable plug into the RETURN three-pin socket on the right side of the motherboard (for more information, see Item 2 and 3 of Plumbing requirements on page 3). For motherboard connection details, refer to "EasyTouch Motherboard Connections," on page 13. For wiring details, refer to "EasyTouch System Wiring Diagram," on page 23. Excess cable can be coiled in the enclosure low voltage raceway left side compartment. Do not coil the wire in upper low voltage compartment.

For Solar Heating use **VLV A** (3-pin socket). Use **VLV B** (3-pin socket) for an optional auxiliary relay.

### Adjusting the valve position

If the valve rotates to the wrong position, adjust the switch on the back of the actuator between ON1 and ON2 positions. This will rotate the valve to the correct position. The following diagram shows the standard plumbing and valve actuator position.

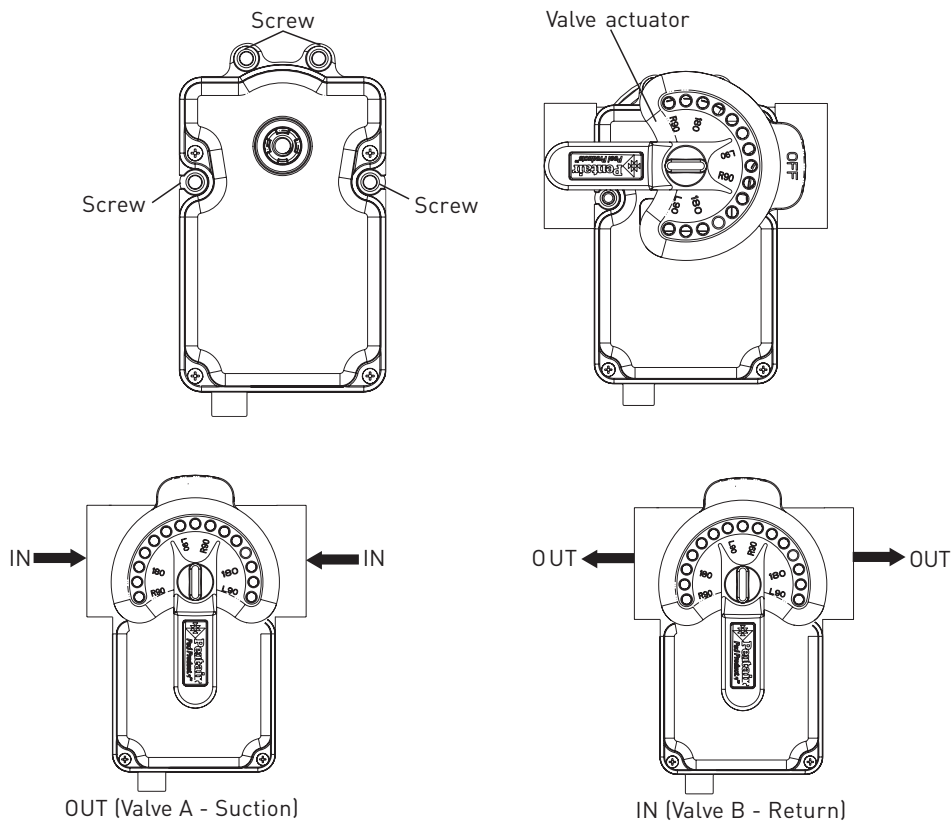



## Installing and Connecting Temperature Sensors

### Water Temperature Sensor

To install the water sensor:

1. Select a convenient location to mount the water sensor in the plumbing system between the filter pump and filter. Drill a 8mm diameter hole in one side of the pipe,
2. Insert tip of sensor into the hole. Use the band clamp to secure the sensor to the pipe. Tighten the clamp just enough so that the o-ring begins to flatten. Do not over-tighten
3. Run the two-conductor cable (included in kit) between the sensor and the Personality board. Route the wire up through the Load Centre low voltage raceway to the Personality board.
4. Fasten the cable to the plumbing with cable ties.
5. Insert the wires into the WATER SENSOR screw terminals (J21) on right-side of the motherboard. For motherboard connection details, refer to "EasyTouch Motherboard Connections," on page 14. For wiring details, refer to EasyTouch System Wiring Diagram," on page 20.

### Ambient Air Temperature Sensor (for freeze protection)

To install the air sensor:

1. Mount the sensor in the open air, in a shaded area, away from air conditioners. During the winter months, to avoid freeze damage to pool and spa equipment, mount the air sensor in a shaded area to assure proper temperature readings. The main screen displays the current ambient air temperature.
2. Route the wire through the low voltage raceway to the motherboard.
3. Fasten the cable to the plumbing with cable ties.
4. Insert the wires into the AIR screw terminals (J21) on right side of the motherboard.

### Solar Temperature Sensor (Optional)

To install the solar sensor:

1. Mount the sensor on a flat surface, with the same exposure to sun as the solar collectors (next to the collectors is recommended) or any sunny location. Do not let the sensor touch the panels. **WARNING: DO NOT DRILL HOLE AND CLAMP SENSOR INTO SOLAR PIPE.** For glazed panels, install the sensor between collector and glazing.
2. If necessary, splice a two-conductor extension wire to the sensor. Run two-conductor cable between the sensor and the Load Centre. Use waterproof connectors to connect the sensor to the cable. Use 2-core 1mm<sup>2</sup> outdoor rated sensor wiring and be sure the wire connections are protected from the environment. Use shielded cable for long runs or runs near other electrical wiring.
3. Insert the wires into the SOLAR SENSOR screw terminals (J21) on right side of the motherboard.

# Electrical Installation

## Connecting the Gas Heater or Heat Pump

The following installation instructions are for gas heaters and heat pumps. To connect the heater fireman switch or external control cable plug to the motherboard:

1. Run a two-conductor cable from the heater fireman switch / external control to the low voltage raceway to the motherboard in the EasyTouch load centre.
2. Strip the conductors 7mm. Insert the wires into the GAS HEATER two-screw terminals (J19) on the motherboard. For wiring details, refer to "EasyTouch System Wiring Diagram," on page 20.
3. At the heater, connect the wires in accordance with heater manufacturer's instructions.
4. Do NOT disconnect or wire around the thermostat, pressure switch, high limit switch, or other safety devices.
5. Select the pool or spa thermostat and toggle the heater to that setting.
6. Turn the thermostat for the selected setting to maximum.

## Pool/Spa Heating Combinations (Recommended Configurations)

Heat Sources	Connections	EasyTouch Configuration
Solar + Gas Heater	Connect gas heater to 2-wire terminal marked "Gas Heater" (J19). Connect solar valve actuator to VLVA (single pump system) or connect solar booster pump electrical outlet relay to "Solar" terminal (separate solar pump system).	Menu>Settings>Solar>Enable = Yes Menu>Heat Menu>Pool Temp/SRC>Solar (or solar preferred). Menu>Heat Menu>Spa Temp/SRC>Heater
Gas Heater Only	Connect gas heater to 2-wire terminal marked "Gas Heater" (J19).	Menu>Heat Menu>Pool Temp/SRC>Heater Menu>Heat Menu>Spa Temp/SRC>Heater
Solar Only	Connect solar valve actuator to VLVA (single pump system) or connect solar booster pump electrical outlet relay to "Solar" terminal (separate solar pump system).	Menu>Settings>Solar>Enable = Yes Menu>Heat Menu>Pool Temp/SRC>Solar
Heat Pump Only	Connect heat pump to 2-wire terminal marked "Gas Heater" (J19).	Menu>Heat Menu>Pool Temp/SRC>Heater Menu>Heat Menu>Spa Temp/SRC>Heater
Heat Pump + Gas Heater	Connect gas heater to 2-wire terminal marked "Gas Heater" (J19). Connect heat pump to relay connected to "Solar" terminal.	Menu>Settings>Solar>Enable = Yes Menu>Settings>Solar>Solar is Heat Pump = Yes Menu>Heat Menu>Pool Temp/SRC>Heat Pump Menu>Heat Menu>Spa Temp/SRC>Heater
Heat Pump + Solar	Connect heat pump to 2-wire terminal marked "Gas Heater" (J19). Connect solar valve actuator to VLVA (single pump system) or connect solar booster pump electrical outlet relay to "Solar" terminal (separate solar pump system).	Menu>Settings>Solar>Enable = Yes Menu>Heat Menu>Pool Temp/SRC>Solar (or solar preferred). Menu>Heat Menu>Spa Temp/SRC>Heater Menu>Settings>Solar>Solar is Heat Pump = NO

## EasyTouch System Start-Up

Perform the following start-up procedures to ensure that the EasyTouch load centre is installed correctly. If you need more detailed operating information, refer to the EasyTouch Pool and Spa Control System User's Guide.

Before you power up the EasyTouch load centre check the following:

### Check Electronics

Check that the following plugs are seated correctly on the motherboard:

- Relay connectors - FLTR PUMP - AUX1 - AUX7 (EasyTouch PNP 10), AUX1 - AUX3 (EasyTouch PNP 5)
- Temperature sensors connectors WATER, SOLAR, AIR
- Transformer wire harness (J1) attached to the motherboard.
- Heater control connector ELEC HTR or two-wire screw terminal.

Refer to EasyTouch System Wiring Diagrams, on page 20.

### EasyTouch System Test

The following describes how to test the main control panel to activate the heater, valves and pumps. Before testing the system, be sure that all pool and spa equipment has been properly installed and connected to the EasyTouch load centre.

### Testing Valve Actuators and Filter Pump

Use the following steps to test the valve actuators (CVA24T) for proper rotation.

To test the valve actuators and pump:

1. Power up the EasyTouch load centre.
2. Press the Mode button on the main control panel. The display shows "SERVICE".
3. Press the Valve (V) button to select POOL.
4. Press the Filter Pump (F) button to activate the filter pump. Water will be removed from the pool and returned to the pool.
5. Repeat steps 3 and 4 selecting Fill (Spillway) then Drain.
6. Set both valve actuators (CVA-24T) for suction and return. Use the toggle switch on the rear of the CVA-24T to withdraw and return water from the pool.

Note: With the filter pump operating, if the water is not being removed and returned to the pool, check that the valve actuator plugs are connected correctly on the motherboard.

### Testing the auxiliary relays

Affix the auxiliary relay labels to the appropriate AUX buttons on the EasyTouch control panel to identify the connected equipment.

- Press the Mode button to enable "Service" pool mode. Press the Filter Pump button (LED on) and each auxiliary (AUX) circuit button, the Heater and Solar buttons to verify the functions. Press the Mode button twice to return the system to "AUTO" mode when done.

# Electrical Installation

## EasyTouch System Wiring Diagram

**WARNING** PREVENT ELECTROCUTION  
 INSTALL ACCORDING TO WIRING RULES AS/NZS 3000 DISCONNECT ALL SUPPLY CONNECTIONS BEFORE SERVICING. THIS APPLIANCE MAY HAVE UP TO 11 SUPPLY CONNECTIONS.

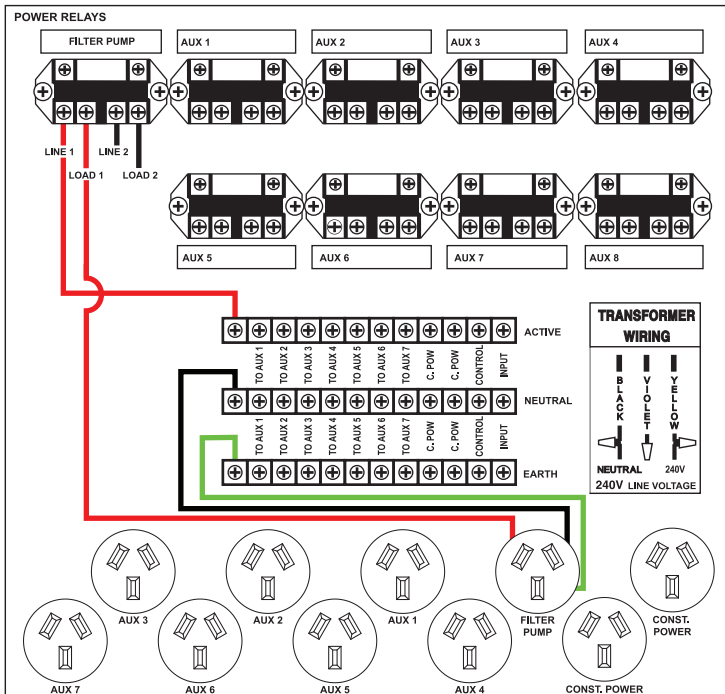
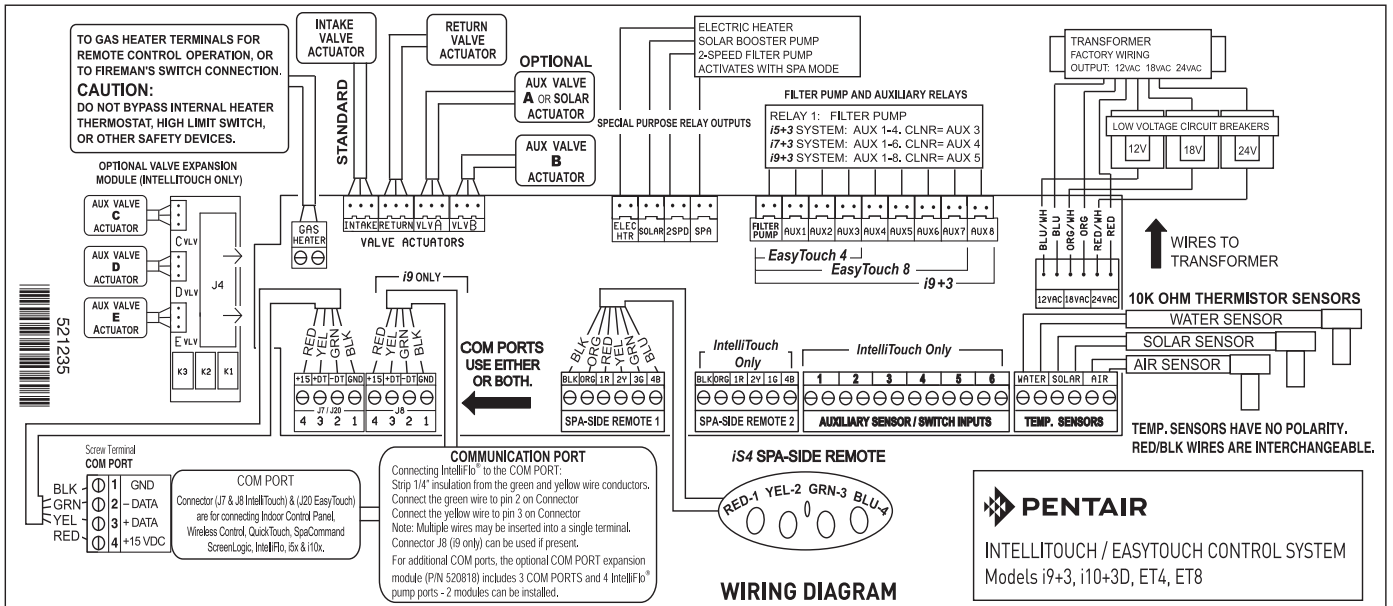

**Input (Control Only):**  
 1A @ 230-240VAC  
 2A @ 120VAC, 50/60Hz

**Input (Control + SCG):**  
 2.3A @ 230-240VAC,  
 4.5A @ 120VAC, 50/60Hz

**MAXIMUM LOAD:**  
 150A, 120-240VAC 50/60Hz

USE COPPER CONDUCTORS ONLY  
 INSTALL IN ACCORDANCE WITH WIRING RULES AS/NZS 3000  
 DOUBLE INSULATED TO WATER CIRCUIT

**Enclosure suitable for INDOOR or OUTDOOR USE. INGRESS PROTECTION: IPX3 NEMA 3R**

**IMPORTANT:** This Control Panel must be installed by a qualified person in accordance with the Wiring Rules (AS/NZS 3000), as well as all statutes and regulations required by the local authority.

Mount enclosure with electrical sockets and conduit holes facing downwards.

This control is not provided with integral RCD protection. Suitable RCD protection shall be provided by the installer in the fixed wiring in accordance with the wiring rules.

A method of disconnection, providing contact separation in both Active and Neutral lines should be provided by the installer.

Make sure connections inside the low and high voltage compartments are well insulated, connectors are properly seated and wiring lugs tightneeed. After wiring is completed, install front panel over wiring compartments and secure with screws provided.

**WARNING**  
 DO NOT USE A CONTROL SYSTEM TO CONTROL AN AUTOMATIC POOL COVER. SWIMMERS CAN BECOME ENTRAPPED UNDER THE COVER, WHICH COULD RESULT IN INJURY AND/OR DEATH.

**INTELLICHLOR®**  
 SALT CHLORINE GENERATOR OPTION

**TRANSFORMER INPUT:**  
 240VAC @ 1.3A, 50/60 Hz  
 Secondary: 28VAC @ 8.9A

**WARNING!** DISCONNECT LOAD CENTER BEFORE SERVICING SCG TRANSFORMER. Connect this chlorinator transformer to the FILTER PUMP RELAY ONLY. The chlorinator would only be powered when the Filter Pump is ON.

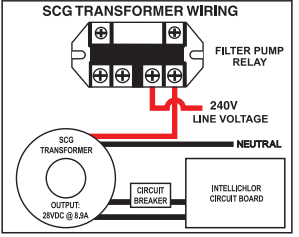

**UL LISTED**  
 POOL/SPA CONTROLLER  
 5K42  
 CoC: A13330EA

**PENTAIR**  
 Customer Support: 1300-137-344

## EasyTouch® Control System Outdoor Control Panel

You can fully automate your pool, spa, and lighting operations from the EasyTouch control system outdoor control panel or from the optional EasyTouch control system indoor control panel and EasyTouch wireless control panel. The EasyTouch control system menu features let you create customized schedules for your pool and spa equipment, heat temperatures, and chlorination settings to switch on and off at a set day and time. Scheduled automatic operations can be performed at either the outdoor control panel, the optional indoor control panel and wireless control panel. For maintenance and service purposes, the outdoor control panel button allows manual control of all pool and spa operations. For menu options, refer to “EasyTouch Menus,” on page 14. The following describes the outdoor control panel buttons, and LED indicators.

- AUTO:** The system is in normal operating mode. Scheduled programs will run automatically.
- HEATER:** Displays the current heat source (Off, Heater, Solar Prf., Solar) when in “Pool” or “Spa” mode, and heat source is enabled (Heater button LED on).
- POOL (SPA):** Indicates that the unit is in “Pool” or “Spa” mode. If this display line is blank, it indicates no spa or pool function is active.
- 25°C / 35°C:** Displays the actual spa or pool water temperature (25°C) and the set point temperature (35°C) as set in the “Heater” menu.
- AIR:** Displays the actual outside air temperature (20°C) as read by the air sensor.
- Day and Time:** Displays the EasyTouch system day and time as specified in the “Clock” menu settings (see page 31).

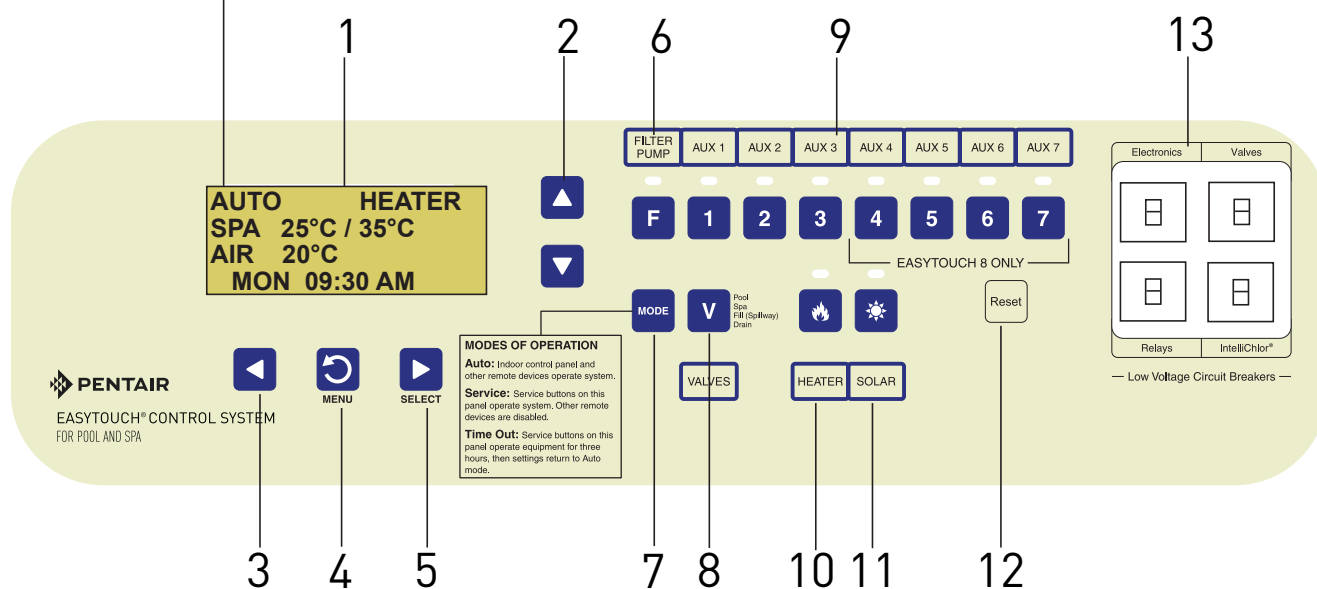





EasyTouch Control System (8 AUX) Outdoor Control Panel





### EasyTouch Control System Controls and Buttons

- ① **Liquid Crystal Display (LCD):** The main system display consists of a 16 x 4 alphanumeric character LCD with EL backlighting for easy viewing of the menu items and status messages. Press the Menu button twice to refresh the display.
- ② **Up/Down buttons:** Use the Up and Down buttons to scroll through the main menu items and to adjust or change settings. Use these buttons after pressing the Menu button to access the main menu items. While editing settings, press and hold the Up or Down button to fast forward or fast reverse through settings and values.
- ③ **Left button:** When in pool or spa mode use the Left and Right button to adjust the temperature level. Press the Left button to lower the set point water temperature. Press the Filter Pump (F) button to display the current water temperature. Use the Left button to scroll through sub-menu selections, setting and values. While editing settings, press and hold the Left button to fast reverse through settings and values.

## Controls and buttons (Continued)

- ④  **Menu/back button:** Use this button to access, save and exit from a current menu or sub-menu settings. Also, while in a menu or sub-menu items, use this button to go back to a previous menu level or item. If no menu activity is detected after five minutes, the main screen is displayed. All menu settings are permanently saved and retained in the control panel even after power is removed from the control panel. Control panel buttons are disabled while in the menu mode.
- ⑤  **Right button:** When in pool or spa mode use the Left and Right button to adjust the temperature level. Press the Right button to raise the set point water temperature. Press the Filter Pump (F) button to display the current water temperature. Use the Right button to select a sub-menu item for editing. After pressing the Menu button to access the main menu items, use the Right button to select the menu item and access the sub-menu items for adjustment. While editing a settings, press and hold the Right button to fast forward through settings and values.
- ⑥  **Filter Pump (F) button/LED:** Switches a single speed filter pump on and off in “Pool” or “Spa” mode. Press the Valves (V) button to toggle between “Pool” and “Spa” mode and rotate valves. If “Heater” is enabled in the “Heat” menu (see page 25), pressing the Filter Pump button will also enable the selected heat source (Heater/Solar LED on). The default time before the filter pump will switch off is 12 hours. This button operates in “Auto” or “Service” mode.
- Single-Speed Filter Pump:** If the pump is currently off, press the Filter Pump button (LED on) to switch the pump on. Press the Filter Pump button again to switch the pump off. However, if the heater is operating, and a delay is enabled for valves, this allows the heater to cool down (heater cool-down), then when you press the F button to switch off the pump, only the heater will turn off, then the filter pump will automatically switch off after 10 minutes to allow the heater to cool down. Pentair heaters do not require a cool down time. To override the “heater cool-down,” press the Filter Pump button again to switch off the pump.
- Two-Speed Filter Pump:** Press the Filter Pump button (LED on) to switch the two-speed pump on in high speed. If you switch the pump off to low speed shortly after switching it to high speed, the filter pump will automatically remain in high speed for a few minutes before switching back to low speed to allow the pump to prime and establish normal water flow. In order to use the “2-Speed Pump” menu assignments (see page 46), the 2-Speed relay option must be installed in the EasyTouch Load Center.
- ⑦  **Mode button:** Use this button for service purposes to manually control the EasyTouch system. Press this button once activate “Service” mode, to allow AUX circuit buttons, Filter Pump, Valves, Heater and Solar buttons to be operated manually. Press the button a second time to enable “Time-out” mode. This mode is similar to “Service” mode except that the system will automatically return to normal operation (Auto) after three hours. Press the button a third time to return the system to “AUTO” mode. The current operating status is shown in the LCD display. The menu buttons, remote controllers, and menu scheduled operations are disabled (except for switching off equipment manually for emergencies) while the system is in “Service” mode.
- Auto:** In Auto (automatic) mode the system is in normal operating mode and is controlled by the main control panel LCD menu features.
- Service:** Use this mode to service pool equipment and to operate equipment manually.
- Time-out:** Same functionality as “Service” mode, except that the system will automatically return to normal operation (Auto) after three hours.

## Controls and buttons (Continued)

- ⑧  **Valves (V) - (Pool/Spa/Fill (Spillway)/Drain) button:** When in normal operating mode, the Valves (V) button is in "Pool" mode. In this mode the valves are automatically rotated so that only the pool water is circulated through the system and the filter pump is activated. Pressing this button once enables "Spa" mode and activates the filter pump to circulate only spa water through the system. "Fill/Spillway" and "Drain" mode can only be used while in "Service" mode (See Mode button for details). "Fill/Spillway" and "Drain" mode are used when cleaning the spa. Pressing the Valves (V) button again returns the system to "Pool" mode. Note that the filter pump will switch off while the pool/spa valves are rotating into position. The current operating mode is shown in the LCD display. Note: The Valves button (Pool, Spa, Fill (Spillway), Drain) button has no function in "Pool only" or "Spa only" systems. For an EasyTouch single body system, "Pool" and "Spa" modes are Lo- Temp (Pool) and Hi-Temp (Spa) temperature controls. For more information, see "Hi-Temp/Lo-Temp Controls for Single Body Systems," page 41.
- ⑨  **Aux 1 - 7 buttons/LEDs:** Auxiliary output circuit buttons operate the pool and spa system valves, lights and other equipment. These auxiliary circuits are assigned in the "Circuit Function" menu, see page 39 for details. There are three auxiliary circuits (AUX 1- 3) on the EasyTouch PNP 5 outdoor control panel and seven auxiliary circuits (AUX 1- 7) on EasyTouch PNP 10 outdoor control panel. The Solar button can also be used for an "extra" auxiliary circuit if the Solar circuit is not being for solar equipment. Labels can be affixed next to each auxiliary button to identify the circuit function. Labels can be affixed over each auxiliary button to identify the circuit function. When an auxiliary circuit is activated or the button is pressed, the LED is on. Pressing an auxiliary circuit button will activate the corresponding circuit in either "Auto" or "Service" mode. When a circuit relay is switched on manually, it remains on until either you switch it off manually, or the next time the relay is scheduled to be switched off. For example, if the filter pump is scheduled to automatically run from 9:00 AM to 5:00 PM daily then the filter pump is switched on manually at 9:00 PM, it will run continuously until the next day at 6:00 PM then switch off. The schedule will then continue from then on.
- ⑩  **Heater (Flame) button/LED:** This button is only used in "Service" mode for manual heat on and off control. The Heater LED will be on if "Heater" is enabled in the "Heat" menu setting (see page 32). Switching the heater on automatically controls the output between a "forced off" state and a normal automatic thermostatic control operating state. The heater will continue heating the water until the heater's current highest set point temperature triggers the heater sensor (approximately 40° C). Note that the Heater button does not activate the pump. Do not activate the heater without running the pump. The heater will not run if water flow is not detected.
- ⑪  **Solar (Sun) button/LED and (Aux Extra):** In solar mode this button is only used in "Service" mode for manual solar heat on and off control. The Solar LED will be on if "Solar" is enabled in the "Heat" menu setting. Solar must also be enabled in the "Solar" menu. Use the Solar button to manually switch the heater control output between a "forced off" state and a normal automatic thermostatic control operating state. When this button is pressed the solar relay is switched on to activate a booster pump if installed and activates valves to rotate to divert water through solar heating panels. If solar equipment is not being used, this button can also be used to switch the AUX EXTRA circuit on and off.
- ⑫  **Reset button:** Press this button to re-initialise the EasyTouch outdoor control panel.
- ⑬ **Low voltage circuit breakers:** Three amp circuit breakers protect the low voltage system motherboard circuits, relays and valves.

## EasyTouch Indoor Control and Wireless Control Panel (Optional)

The EasyTouch Wireless or the Indoor Control Panel allows you to control your pool and spa daily operations from around your pool area or inside your home. Use the "P" (Pool) and "Spa" (Pool) buttons to heat and filter your pool and spa. The Indoor Control Panel connects to the EasyTouch motherboard in the load center. For more information refer to the EasyTouch Indoor Control Panel User's Guide (P/N 520616) and the EasyTouch Wireless Control Panel User's Guide (P/N 520688).

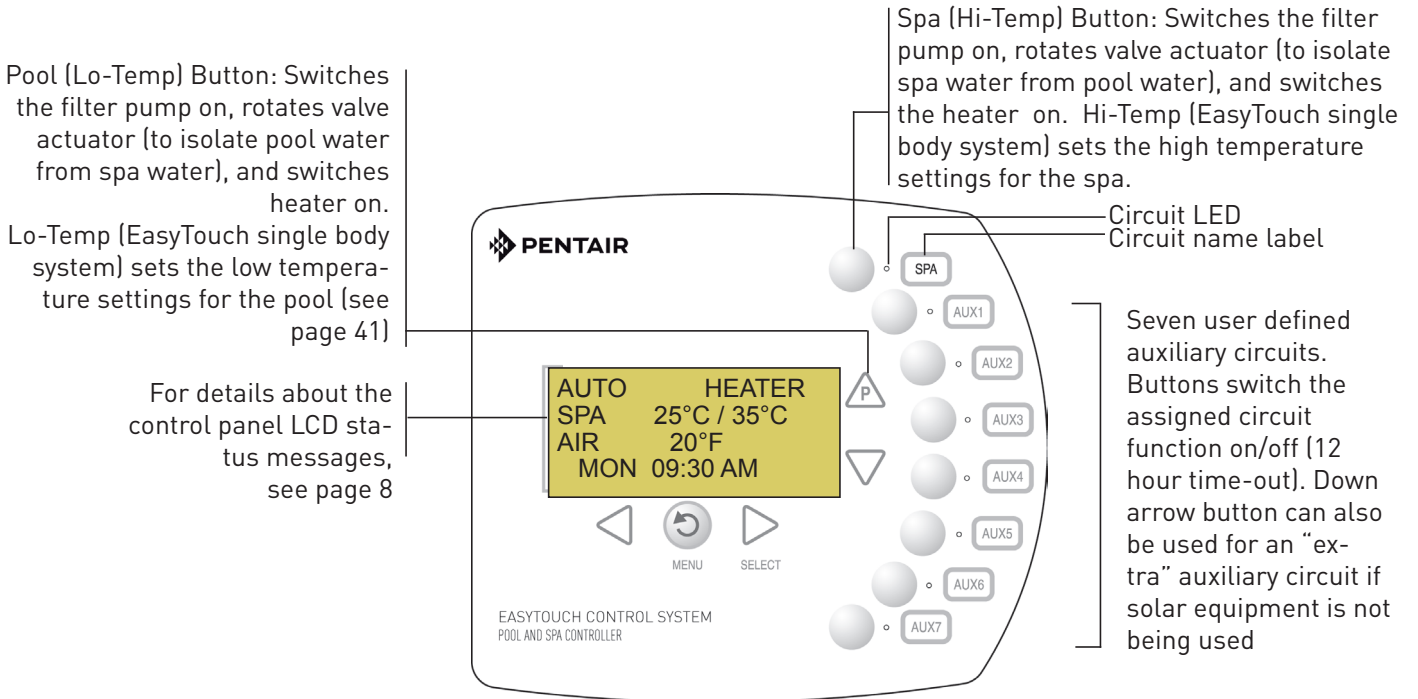

EasyTouch indoor control panel (EasyTouch 8) - (P/N 520549)

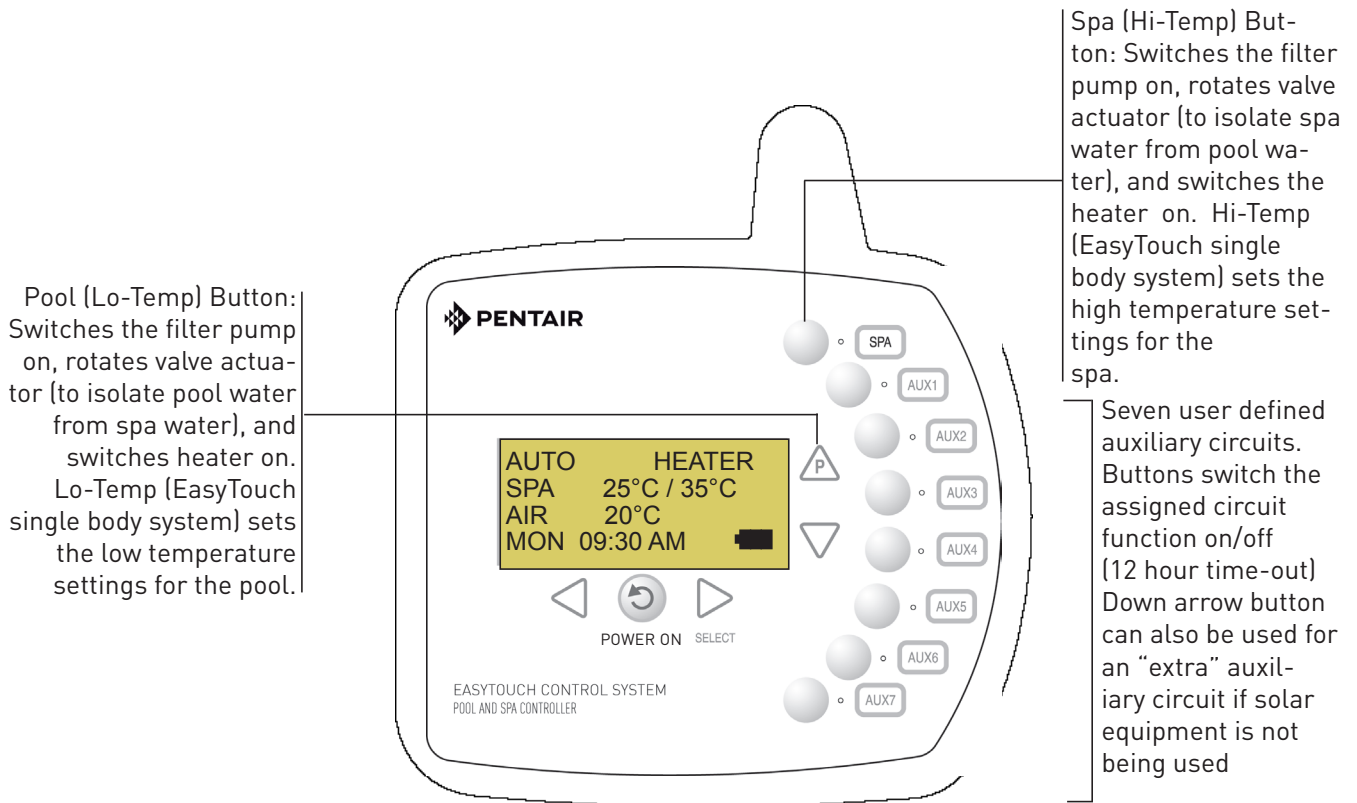

EasyTouch wireless control panel (EasyTouch 8) - (P/N 520547)



## EasyTouch Menus

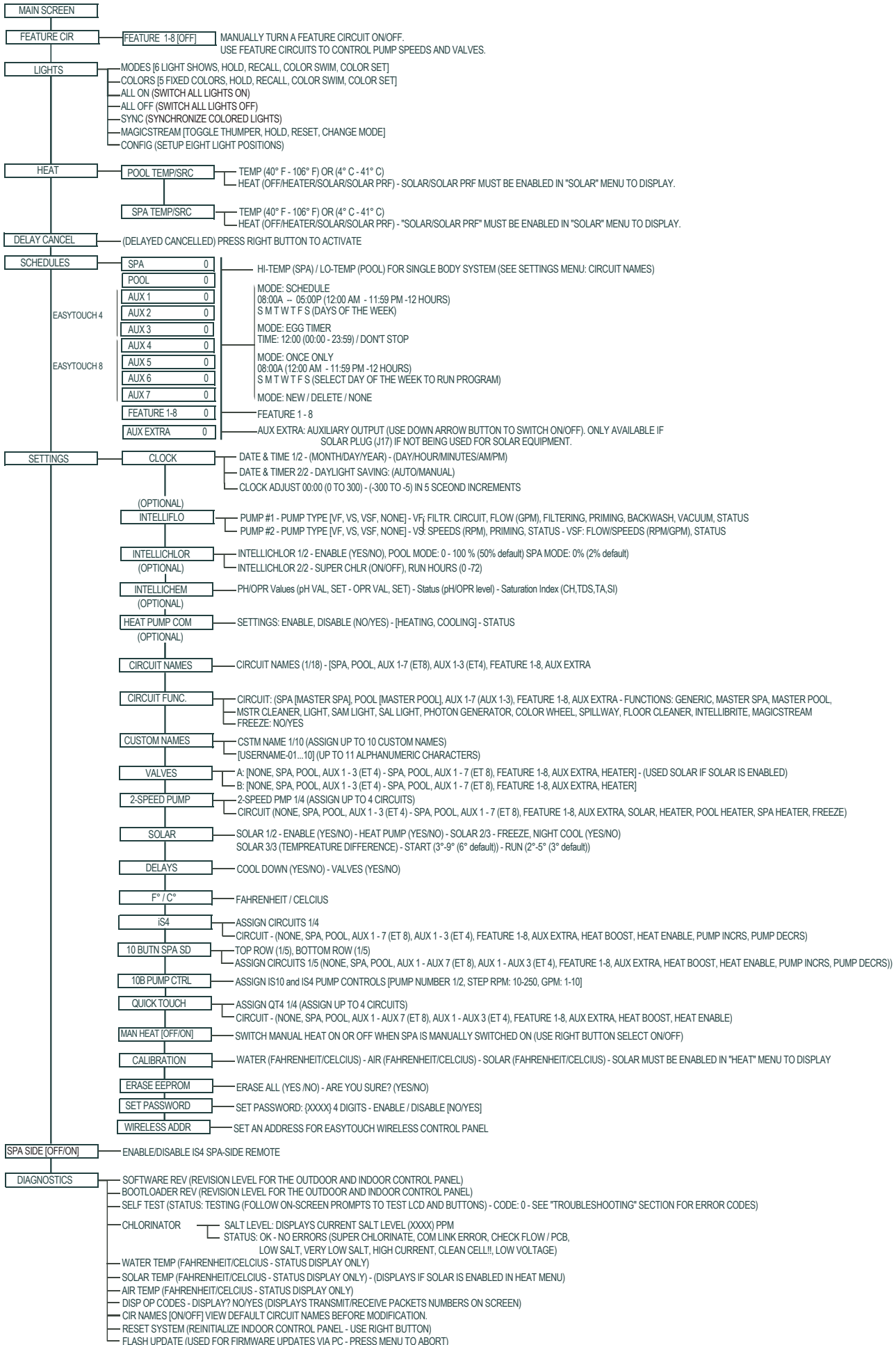

## Programming EasyTouch (Step By Step)

1. Set the system date and time (Page ).

### Getting There

MENU ▼ SETTINGS ► CLOCK

2. Set temperature units to metric/Celsius (Page ).

### Getting There

MENU ▼ SETTINGS ▼ ENGLISH/METRIC ► F°/C°

3. Assign circuit names (Page )

### Getting There

MENU ▼ SETTINGS ► CIRCUIT NAMES

4. Assign a "Circuit Function" to a "Circuit Name" (Page )

### Getting There

MENU ▼ SETTINGS ► CIRCUIT FUNC.

5. Deactivate Freeze Protection on Pool and Spa circuits (Page )
6. Configure heating options (Page ).

### Getting There

MENU ▼ HEAT ►

7. Configure IntelliFlo Pump (Page ).

### Getting There

MENU ► SETTINGS ► INTELLIFLO ► PUMP#1

8. Configure valve actuators (Page ).

### Getting There

MENU ▼ SETTINGS ▼ VALVES ► SETUP VALVES

9. Schedule on/off times for automatic circuit activation (Page ).

### Getting There

MENU ▼ SCHEDULES ►

10. Configure Spa-Side remotes (Page ).
11. Optional - Advanced set-up (Page ).

## Set the System Date and Time

Use the Clock menu to set the EasyTouch system date and time. The day, time and AM/PM is displayed on the main screen. The system clock settings are used for the EasyTouch system scheduled operations. The EasyTouch system clock will continue to run if power is removed from the EasyTouch system at the load center.



To set the system date and time:

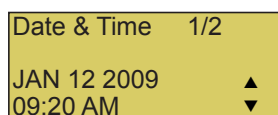

**Right button:** Move to the day setting.

**Up/Down buttons:** Set the day of the month.

**Right button:** Move to the year setting.

**Up/Down buttons:** Set the year.

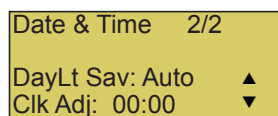

**Right button:** Move to the next set of settings (2/2).

**Up/Down buttons:** Set Daylight Savings to Auto or Manual. Auto keep track of the semi annual time changes. If you do not live in an area that observes daylight savings time, choose Manual.

**Right button:** Move to the clock adjustment setting. If the internal system clock loses time during the month, use this setting to set the number of seconds in five second increments per month to automatically adjust the clock to the correct time.

**Up/Down buttons:** Adjust the offset in five second increments.

Press the **Menu** button to save the settings and to return to the Settings menu options. Press the button again to return to the main menu options or press again to return to the main screen.

## Settings Menu: English / Metric (Fahrenheit/Celsius)

The temperature settings for the water, solar and air can be displayed in either Fahrenheit or Celsius.



English (F°) / Metric (C°)

To change the temperature units:

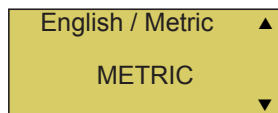

**Up/Down buttons:** Select either English (Fahrenheit) or Metric (Celsius). Press the Menu button to save the settings and to return to the Settings menu options. Press the **Menu** button again to return to the main menu options or press again to return to the main screen.

# Programming EasyTouch: Circuit Names

## Circuit Names

### Labelling Circuit Buttons in the EasyTouch Load Centre

EasyTouch is factory configured to display each output circuit by its generic name (e.g. AUX 1, AUX 2, etc.). These generic circuit auxiliary names can be assigned a new names which are more descriptive of the equipment being controlled. This makes it much easier to operate all of the pool, spa and lighting equipment without having to memorize what each output controls.

For circuit identification, adhesive backed circuit name labels are provided for placement next to each auxiliary control panel button. Use the written list of circuit names (buttons) that you made while setting up the EasyTouch system load centre. Identify what you labelled circuit button 1, button 2 etc. The circuit names you assign should match the labels you put on the EasyTouch load centre control panel buttons and/or the optional Indoor Control Panel buttons. Note that examples shown below use the factory set generic output names displayed in the EasyTouch control panel menus.

To assign circuit names:

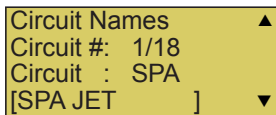

**Up/Down buttons:** Select the circuit number 1/18. Press the **Up button** two times to select AUX 1. **The generic circuits names are: Spa (1/18), Pool (2/18), Aux 1-7 (EasyTouch PNP 10), Aux 1-3 (EasyTouch PNP 5), Ft 1. (10/18) - Ft. 8 (17/18), AuxX (18/18 - Aux Extra).** The circuit number 1/18 corresponds to its assigned circuit name. This name can be changed to suite the function. Aux Extra is only available if the Solar output (J17) plug on the EasyTouch motherboard is not being used for solar equipment. Use the Solar button to switch the “extra” auxiliary circuit on and off.

**Right button:** Move to EasyTouch preset circuit names and user defined custom circuit names.

**Up/Down buttons:** Scroll through the list of alphabetical programmed names. If you cannot find a name to match your circuit, you can create your own custom name (see page 29). Repeat for all the circuit buttons that you wish to assign names to. For a complete list of EasyTouch circuit names, see page 29.

Press the **Menu** button to save the settings and to return to the Settings menu options. Press the button again to return to the main menu options or press again to return to the main screen.

**Note:** After a generic circuit name is changed and saved, the new name is displayed in the menu settings. You can view the default generic circuit names in the menu settings before they were changed by enabling “Cir Names.” Refer to “Diagnostics: Cir Names (Off),” on page 60.

## EasyTouch Circuit Names

AERATOR	DRAIN LINE	MALIBU LTS	SPA LOW
AIR BLOWER	DRIVE LIGHT	MIST	SPA SAL
AUX 1	EDGE PUMP	MUSIC	SPA SAM
AUX 2	ENTRY LIGHT	NOT USED	SPA WTRFLL
AUX 3	FAN	OZONATOR	SPILLWAY
AUX 4	FIBER OPTIC	PATH LIGHTS	SPRINKLERS
AUX 5	FIBER WORKS	PATIO LTS	STREAM
AUX 6	FILL LINE	PERIMETER L	STATUE LT
AUX 7	FLOOR CLNR	PG2000	SWIM JETS
AUX 8	FOGGER	POND LIGHT	WTR FEATURE
AUX 9	FOUNTAIN	POOL PUMP	WTR FEAT LT
AUX 10	FOUNTAIN 1	POOL	WATERFALL
AUX EXTRA	FOUNTAIN 2	POOL HIGH	WATERFALL 1
BACKWASH	FOUNTAIN 3	POOL LIGHT	WATERFALL 2
BACK LIGHT	FOUNTAINS	POOL LOW	WATERFALL 3
BBQ LIGHT	FRONT LIGHT	POOL SAM	WHIRLPOOL
BEACH LIGHT	GARDEN LTS	POOL SAM 1	WTRFL LGHT
BOOSTER PUMP	GAZEBO LTS	POOL SAM 2	YARD LIGHT
BUG LIGHT	HIGH SPEED	POOL SAM 3	FEATURE 1
CABANA LTS	HI-TEMP	SECURITY LT	FEATURE 2
CHEM. FEEDER	HOUSE LIGHT	SLIDE	FEATURE 3
CHLORINATOR	JETS	SOLAR	FEATURE 4
CLEANER	LIGHTS	SPA	FEATURE 5
COLOR WHEEL	LOW SPEED	SPA HIGH	FEATURE 6
DECK LIGHT	LO-TEMP	SPA LIGHT	FEATURE 7
			FEATURE 8

## Settings Menu: Custom Names

There are nearly 100 circuit names available to choose from. If you cannot find one to fit your application you can create up to 10 custom names. Each name can be up to 11 alphanumeric characters. After a custom name is saved, it is then available for selection in the Schedules, 2-Speed Pump, iS4 and QuickTouch menus.

### Getting There

MENU ▼ SETTINGS ▼ CUSTOM NAMES ►

To assign a custom circuit name:

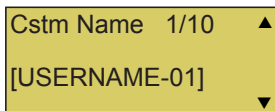

**Up/Down buttons:** Select a custom circuit name number (1-10). You can create up to 10 custom circuit names.

**Right button:** Move to custom circuit name setting.

**Up/Down/Right buttons:** Enter the custom circuit name (11 characters maximum).

Press the **Menu** button to save the settings and to return to the Settings menu options. Press the button again to return to the main menu options or press again to return to the main screen.

# Programming EasyTouch: Circuit Functions

## Circuit Functions

### Assigning Circuit Functions

#### Getting There

MENU ▼ SETTINGS ► CIRCUIT FUNC.

From the “Circuit Functions” menu you can assign special logic to the cleaner pump, spa spillway, lights and MagicStream laminar circuits. For example, when setting up an automatic pool cleaner pump you would assign the circuit function “MASTER CLEANER.” With this “Cleaner” logic the cleaner pump would force the filter pump on, and the cleaner pump would start after a delay of five minutes. The cleaner pump would automatically shut off whenever the spa and/or solar is switched on.

Circuit/Func.: ▲  
[SPA ]  
[Master Spa ]  
Freeze: No ▼

**Up/Down buttons:** Choose the circuit name (displayed on the second line). The generic circuits names are: **SPA [MASTER SPA], POOL [MASTER POOL], AUX 1-7, FEATURE 1-8 and AUX EXTRA\* or SOLAR (if enabled in the Solar menu).**

**Right button:** Move to the “Circuit Function” setting to select the circuit function for the select circuit name displayed on the line above.

Circuit/Func.: ▲  
[AUX 1 ]  
[LIGHT ]  
Freeze: No ▼

**Up/Down buttons:** Select the circuit function. This is the circuit that you wish to assign the function logic to. For a complete list of preset circuit functions, see table below.

Press the **Menu** button to save the settings and to return to the Settings menu options. Press the button again to return to the main menu options or press again to return to the main screen.

\*AUX EXTRA is only available if the Solar output (J17) plug on the EasyTouch motherboard is not being used for solar equipment. Use the Solar button to switch the “extra” auxiliary circuit on and off.

## Freeze Protection

Freeze protection switches on a circuit if the outside air temperature sensor detects the temperature is getting close to freezing (below 2°C). The system will switch on all circuits that have been assigned freeze protection, and runs the circuits for 15 minutes to stop the pipes from freezing. This is especially important if the pool is in a cold climate where the temperature is cold enough to freeze water in the pipes and equipment. **IN MOST PARTS OF AUSTRALIA & NEW ZEALAND FREEZE PROTECTION IS UNNECESSARY.** If freeze protection is set to both the spa and pool circuits, the filter pump switches on and the pool and spa valves alternate every 15 minutes to keep the water moving in both the pool and spa. This process continues until the freeze condition is over. Freeze protection is ON by default for the Pool and Spa circuits, unless you are located in an alpine region in Australia or Southern New Zealand, you should deactivate it.

#### Getting There

MENU ▼ SETTINGS ► CIRCUIT FUNC.

To deactivate/activate freeze protection:

Circuit/Func.: ▲  
[SPA ]  
[Master Spa ]  
Freeze: Yes ▼

**Up/Down buttons:** Choose the circuit name (displayed on the second line).

**Right button:** Move to the “Freeze” setting to select the circuit for the freeze protection.

Circuit/Func.: ▲  
[SPA ]  
[Master Spa ]  
Freeze: No ▼

**Up/Down buttons:** Select “No” to deactivate circuit freeze protection. Select “Yes” to activate circuit freeze protection. Press the **Menu** button to save the settings and to return to the Settings menu options. Press the button again to return to the main menu options or press again to return to the main screen.

## Settings Menu: Circuit Functions (Continued)

Generic	No special Logic. Simple On/Off control of a circuit with all the programmable capabilities.
Master Spa	Fixed "Spa" mode function. It does the following: <ul style="list-style-type: none"><li>- Turns filter pump on.</li><li>- Turns Intake and Return Valves to Spa positions.</li><li>- Sets temperature and turns on heat source to Spa settings, as defined in the heat menu.</li><li>- Switches the "Master Cleaner" circuit off when the spa is on.</li></ul>
Master Pool	Fixed "Pool" mode function. It does the following: <ul style="list-style-type: none"><li>- Turns filter pump on.</li><li>- Turns Intake and Return Valves to Pool positions.</li><li>- Sets temperature and turns on heat source to Pool settings, as defined in the heat menu.</li></ul>
Master Cleaner	Works with pressure-side pool cleaner pumps or in-floor cleaning pumps. It does the following: <ul style="list-style-type: none"><li>- Forces the filter pump on 5 minutes before the cleaner pump switches on.</li><li>- Switches the cleaner pump off when the spa is on.</li><li>- Switch the cleaner off for 5 minutes when the solar heating begins.</li></ul>
Spillway	For pool/spa combinations where the spa is raised above the pool. This setting moves the return valve so that the filter pump pulls the water from the pool and returns it to the spa, creating a water fall effect. Automatic pool cleaners are turned off when this feature is turned on.
Floor Cleaner	This setting moves a 3-way valve every 20 minutes alternating flow between 2 cleaner system valves that feed the pop-up heads.
Light	Allows special lighting features to work, such as ALL lights on or ALL lights off.
IntelliBrite	Activates special colour lighting program for Pentair IntelliBrite, GloBrite, Color-Cascade, ColorVision and MagicStream* lights.
MagicStream	Activates special program for Pentair MagicStream* laminars.
SAM Light	Activates special colour lighting program for older SAM type lights.
SAL Light	Activates special colour lighting program for older SAL type lights.
Photon Generator	Activates special colour lighting program for older Photon Generator type lights.
Color Wheel	Activates special colour lighting program for older Color-Wheel generator type lights.
Valve	For possible future use, currently no special function.

\*MagicStream laminars can be configured in either standard MagicStream mode or IntelliBrite mode. To configure a MagicStream laminar to either mode, please refer to the MagicStream owners manual.

# Programming EasyTouch: Heat

## Heat Menu

Use the heat menu settings to specify the set point temperature and select the heat source for the pool and spa water. The water will begin to heat whenever the water temperature is below the set-point. There is a different set point for "Pool" and "Spa" modes, you can switch between modes by pressing the Valves (V) button (on the Outdoor Control Panel) or the "Pool" or "Spa" button on the Indoor Control Panel. The spa will also begin to heat when switched on by the optional iS4/SpaCommand Spa-Side remote, or EasyTouch wireless remote. The EasyTouch system allows for solar and conventional heaters. The EasyTouch will use the heating source that is selected. The heat source selections are:

- OFF - No heating even though pump and other circuits may be operating.
- HEATER - Gas heater only. Use the Heater button to automatically switch the heater on which controls the output between a "forced off" state and a normal, automatic thermostatic control operating state. The heater will continue heating the water until the heater's current highest set point temperature triggers the heater sensor (40° C). Note that in Service mode, the Heater button on the control panel does not activate the pump. Do not activate the heater without running the pump. The heater will not run if water flow is not detected.
- SOLAR ONLY - Solar heating system to be the only heat source. In order to display solar options on the main screen, you must first enable solar in the "Solar" menu (see following section).
- SOLAR PREF. (Solar Preferred) - Solar and gas heating systems are installed, and you want to use solar heating only when it is most effective.

To set the pool temperature and select the heat source:

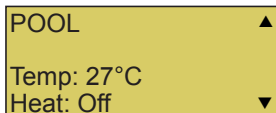
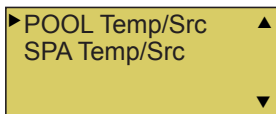

**Right button:** Select pool temperature and heater options.

**Up/Down button:** Set the pool temperature from 4°C - 40°C.

**Right or Left button:** Move to Heater option.

**Up/Down:** Set Heater option: **Off, Heater, Solar, or Solar Preferred.**

Press the **Menu** button to save the settings and to return to the previous menu or press the button again to return to the main screen.

To set the spa temperature and select the heat source:

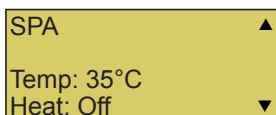
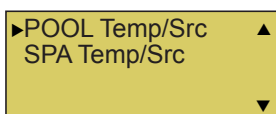

**Right button:** Select spa temperature and heater options.

**Up/Down button:** Set the spa temperature from 4°C - 40°C).

**Right or Left button:** Move to Heater option.

**Up/Down:** Set Heater option: **Off, Heater, Solar, or Solar Preferred.**

Press the **Menu** button to save the settings and to return to the Heat menu or press the button again to return to the main screen.



## Solar

Use the solar settings to setup solar or configure solar as a heat pump:

**Setting Up Solar Control:** Ensure that the solar temperature sensor is installed.

**About Installing Solar Heating:** First, install the solar sensor at the collectors and connect to the EasyTouch load center. Connect the wires to the SOLAR screw terminals according to the wiring diagram on page 64. Plug the solar valve actuator cable into three-pin socket marked VLV A on the EasyTouch motherboard. If a solar booster pump is being installed, connect the pump to a power relay and plug a low voltage cable from relay into the two-pin socket marked SOLAR on the EasyTouch motherboard.

If HEAT PUMP is selected and is being used in place of a solar heating system, install Solar sensor near the EasyTouch Load Center.

**Note: If Solar is not selected (No), the EasyTouch menu selections display “AUX EXTRA” instead of “SOLAR.” This allows the solar plug (J17) on the EasyTouch motherboard to be used as an “extra” auxiliary output circuit. The Solar button is used to switch on and off the extra auxiliary circuit.**

To access the Solar menu:

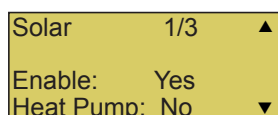

Press the **Up/Down button** to select which solar screen to view. Press the **Right button** to select the setting and the **Up/Down button** to change a setting or value.

**Screen (1/3): ENABLE SOLAR:** Is the pool using solar heat? Select **Yes** or **No** to enable solar heat. To display the solar selection as a heat source in the main screen, select **Yes**.

**HEAT PUMP:** Is a heat pump being used for solar heat? Select **Yes** or **No** to enable solar as a heat pump. **Heat Pump Control instead of Solar:** Select **YES** if a heat pump is being used in place of a solar heating system. If Solar is set to heat pump, **Valve A** is free for other circuits.

**Right button:** Select **2** of 3 (**2/3**) to access the freeze and night cooling features.

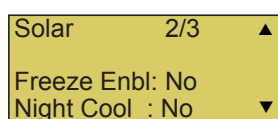

**Screen (2/3): ENABLE FREEZE:** Enable freeze protection when using solar heat. Select **Yes** or **No** to enable freeze solar protection.

**ENABLE NIGHT COOLING:** Select **Yes** or **No** to enable nocturnal cooling. Night cooling enabled (YES), will circulate water through the system to lower the temperature during the night hours. Set the temperature in the Heat menu.

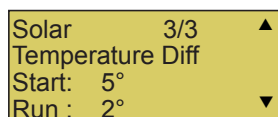

**Screen (3/3): Solar temperature differential start up and run settings.**

**Start:** Set the temperature differential to start heating from 1° to 5°. For example, if “Start” is set to 5°, this ensures that the solar temperature has to raise by 5° above the water temperature before it switches on. Once the solar comes on it will start converging as it is heating. This ensures that it will not continually be switching on and off.

**Run:** Set the temperature differential to stop heating from 2° to 5°. This setting sets how close to the target set point temperature to switch off solar heat. Press the **Menu** button to save the settings and to return to the Settings menu options. Press the button again to return to the main menu options or press again to return to the main screen.

# Programming EasyTouch: IntelliFlo

## IntelliFlo® Menu

### Connecting power to an IntelliFlo pump

The IntelliFlo pump is designed to be permanently connected to its power source. No relay connected outlet is required. The IntelliComm cable controls the starting and stopping of the pump. When the IntelliFlo pump is connected to the EasyTouch automation system, the drive must be powered up to receive and respond to the RS-485 serial communication from the automation system. The EasyTouch PNP includes dedicated 15A permanent power outlets (one on the EasyTouch PNP 5 and two on the EasyTouch PNP 10).

### How many IntelliFlo pumps will EasyTouch support?

EasyTouch can support a total of two IntelliFlo pumps in any combination with up to eight GPMs or RPMs per pump. For example pumps can be connected to EasyTouch as follows:

- 1 IntelliFlo VF + 1 IntelliFlo VS
- 2 IntelliFlo VF
- 2 IntelliFlo VS

Selecting the IntelliFlo PUMP TYPE

#### Getting There

MENU ► SETTINGS ► INTELLIFLO ► PUMP#1

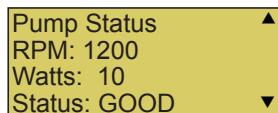
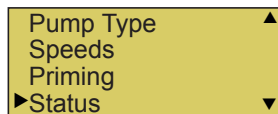
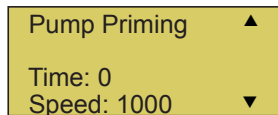
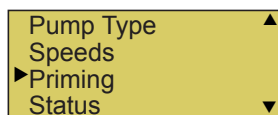
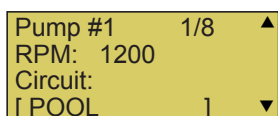
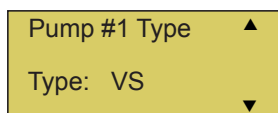
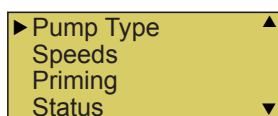
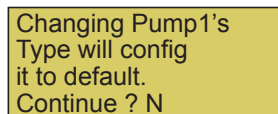
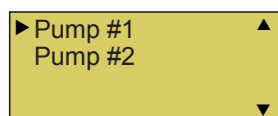

**Up/Down button:** Choose **Pump #1**. (To assign a circuit to Pump #2, be sure to change the pump to “ADDRESS 2” on the pump’s control panel, see below instructions).

**Right button:** Select **Pump #1**.

**Right button:** Select **Pump Type**. Note: To change the current pump type for Pump #1. press the **Up/Down** button and select **Y**, then press the **Right button**. To continue to the Pump #1 settings menu, press the **Right button** (or **Menu** to exit).

**SELECT PUMP TYPE: Up/Down buttons:** Choose **VS** or **VF**.

**Menu button:** Press the **MENU** button to save selection and return to the selected pump’s menu settings (see VS, and VF pump settings descriptions below).

#### INTELLIFLO VS SPEEDS SETTING:

**Down button:** Choose **Speeds**.

**Right button:** Access the IntelliFlo VS speed (RPM) settings for Pump #1.

**Up/Down button:** Select the **circuit number 1 of 8** (1/8).

**Right button:** Move to **RPM** to change the pump speed.

**Up/Down buttons:** Set speed of the pump from 400 to 3450 RPM in increments of 10 RPM. The default speed for each circuit correspond to the four speed buttons on the IntelliFlo VS control panel is: **Speed 1 button 750 RPM, Speed 2 button 1500 RPM, Speed 3 button 2350 RPM, and Speed 4 button 3110 RPM.**

#### INTELLIFLO VS PRIMING SETTING:

**Down button:** Choose **SPEEDS**.

**Right button:** Access the priming settings.

**Up/Down button:** Adjust the priming time from 0 to 5 minutes.

**Right button:** Move to **SPEED (RPM)** to change the pump speed.

**Up/Down buttons:** Set speed of the pump from 400 to 3450 RPM in increments of 10 RPM. The default speed for each circuit correspond to the four speed buttons on the IntelliFlo VS control panel is: **Speed 1 button 750 RPM, Speed 2 button 1500 RPM, Speed 3 button 2350 RPM, and Speed 4 button 3110 RPM.**

#### INTELLIFLO VS STATUS SETTING:

**Down button:** Choose **STATUS**.

**Right button:** View the current VS status.

**Menu:** Press **MENU** to exit.

## IntelliFlo VF Pump Settings

Pump Type	▲
►Filt. Circuit	
Flows	
Filtering	▼

►Priming	▲
Backwash	
Vacuum	
Status	▼

Pump #1	1/8	▲
GPM : 30		
Circuit:		
[AUX 1 ]		▼

Pump #1	1/8	▲
GPM : 30		
Circuit:		
[AUX 1 ]		▼

**TO CHANGE THE PUMP TYPE:** Press the **Right button** to Select **Pump Type**.

Press the **Up/Down button** and select **Y**, then press the **Right button**. Press the **Up/Down button** to change the pump type to **VS or VF**. Press **MENU** to save and return to the selected pump's settings.

**FILT. CIRCUIT:** Press **Down button**, Choose **FILT > CIRCUIT**. Press **Up/Down button** to select the pool filter circuit: **NONE, SPA, POOL, AUX 1-7 (ET8), AUX 1-3 (ET4)** and **FEATURE 1-8**. Press **MENU** to save.

**VF FLOWS:** Press **Down button:** Choose **Flows**. Press **Right button:** Access the IntelliFlo VF flow settings. Press the **Up/Down buttons** to set **GPM (15-130)**.

Press **Right button** to **CIRCUIT** for circuit **1** of **8**. Assign the circuit: **NONE, SPA, POOL, AUX 1-7 (ET8), AUX 1-3 (ET4), FEATURE 1-8, SOLAR** (if enabled in the Solar menu) or **AUX EXTRA** (only if Solar is not selected, see page 25 and 42), **HEATER, POOL HEATER, SPA HEATER, FREEZE, and HI\_SPEED**. **AUX EXTRA** is only available if the Solar output (J17) plug on the EasyTouch motherboard is not being used for solar equipment. After circuit selection is finished, press

**Right button:** Press the **Up arrow button** and go to the next circuit page settings (**2/8**) and repeat **GPM** and **CIRCUIT** settings setup. Up to eight (**8**) circuits can be assigned.

When finished, Press the **MENU button** to save and exit to previous menu.

**Press Down/Up button to select FILTERING, PRIMING, BACKWASH, VACUUM, or STATUS.** Press the **Right button to access settings:** Press the **Up/Down buttons** to set parameters. See IntelliFlo VF parameter descriptions below:

When finished setting up a parameter, press the **Menu** button to save the settings and to return to the IntelliFlo VF setting menu. When finished setting up all of the IntelliFlo VF pump parameters, press the **Menu** button until the main screen displays.

Pump Filtering	▲
Size : 1500	
Turns : 2	
Man Filt: 0	▼

**Filtering** -Pool Size/Gallons: 0 - 255 (Kgals) - Turnovers per day: (1 - 8)

Filtering Manual Filter GPM: (15 - 130) Default 30 GPM: Manual Filter sets the flow at which the pump will run if it is turned on manually. The IntelliFlo pump will only run in the 'Filter' mode during the programmed times. For example, if the pump is programmed (start/stop times) for the pool circuit to run from 8:00 AM to 4:00 PM everyday. This program or programs are used by IntelliFlo to calculate at what speed it must run given those 'ON' times to achieve the turnover(s) for that sized pool for the basic filter mode.

Pump Priming	▲
Max Flow : 55	
Max Time : 5	
Sys time : 0	▼

**Priming** - Max Prime Flow GPM: (30 - 130) Default 55 GPM: Every time the pump starts this parameter will negotiate the maximum flow of the pump. If the flow is too high, equipment damage can occur. If the flow is too low the pump will not prime. This "flow" is system dependent and may require adjustment. The pump will never flow more than this parameter is set to, however, it is common for the pump to ramp up and down quickly while priming. Always try to keep this flow as low as possible for cost savings and safety.

Max Prime Time: (1 - 15 minutes) Default 15 min.: Use this parameter to set the time that you want IntelliFlo try and prime before it reports an error. Remember that the IntelliFlo will attain prime every time it starts and goes through this cycle. The IntelliFlo mechanical seal can withstand about 15 minutes before severe damage occurs. The lower the time the quicker you will get a priming error if the system is difficult to prime. A well plumbed pool without having the strainer removed should prime in less than 30 seconds. If the strainer has been removed for cleaning and a substantial amount of air is in the system it should prime in about 60 to 90 seconds on the average, however, all systems will be different.

Priming - System Prime Time: (0 - 5 minutes) Default 0 min.: Remember that the average unit will prime in a short period of time because the IntelliFlo has the ability to monitor itself to make sure it is primed. "System Prime Time" is for systems that require high flows that priming flow can provide but it is deemed that more time is needed to fully relieve all the air. The builder can program a pre determined amount of time, up to 5 minutes, to aid in relieving the air from difficult filters or complex vertical plumbing. The "System PrimeTime" should only be used where large air traps become problems within the system. The display will inform the user when this is engaged and when it is finished during the priming cycle at each start up cycle.

Backwash Clean ▲  
Filt : 10  
Flow GPM : 60  
Duration : 5 ▼

**Backwash** - Clean Filter PSI (1 - 50 psi) Default 14 PSI The average PSI setting is between 10 PSI and 20 PSI for most pools and filters. The entered PSI value splits the percentage meter for the filter. When the ""clean filter"" value is reached, EasyTouch displays an alert message and the pump stops monitoring flow rates and starts managing pressure. The value represents the change in pressure over time from start up (system clean) to present day (system getting dirty). The changes can come from anywhere in the system, for example clogged skimmers or pots in pumps. Setting this parameter at a lower level will cause the alert message to come up sooner and you will have to clean your filter (cartridge) or backwash your filter (sand or DE) sooner.

Backwash Flow GPM (15 - 130 GPM) Default 60 GPM.

Backwash Duration (1-60 minutes) Default 5 minutes.

Rinse Time (1-60 minutes) Default 1 minute.

Pump Vacuum ▲  
Flow (gpm) : 50  
Time (min) : 10 ▼

**Vacuum** Flow GPM (15-130 GPM) Default 50 GPM

This setting sets the GPM that the pool vacuum will use.

Vacuum Time Mins. (1 - 600 minutes (10 hours) Default 10 minutes

This parameter can be set from 1 to 600 minutes. The typical setting is 10 minutes. This setting sets the amount of time you wish to run the pool vacuum.

GPM: 73 ▲  
1927 RPM 1980 W  
Filter: 7  
Status: NORMAL ▼

**Status** screen: Displays current operating information: GPM, RPM, Filter minutes, and pump communication status.

**NOTE: INTELLIFLO "FREEZE" PROTECTION** - If the IntelliFlo pump is on due to a freeze condition (not switch on from a relay circuit state), and if a freeze speed/flow is set in IntelliTouch, this setting takes priority even if the previous setting is lower than the default circuit speed. If no "freeze" protection is set, the pump will be forced **on** at the default circuit speed/flow. Any programmed or manual operation that actually switches on a circuit, will cause the pump to run at that speed if it is higher.

**NOTE: INTELLIFLO IN "SERVICE MODE"** - The IntelliFlo pump will STOP when EasyTouch is in 'Service' mode.

**NOTE: INTELLIFLO VF PUMPS** - If the IntelliFlo VF pump is just starting (requiring a prime) and SOLAR is available, solar will be delayed for five (5) minutes to allow the pump to prime. This only applies for IntelliFlo pump(s) assigned as to a "pool" pump.

## IntelliFlo Menu(Continued)

### Assigning an IntelliFlo Pump Address

When using multiple IntelliFlo pumps with EasyTouch you need to assign an address to each pump. The address can be set to #1 or #2. The address set at the pump must match the IntelliFlo pump number selected in the EasyTouch IntelliFlo **PUMP # > PUMP TYPE** menus. When only using one IntelliFlo pump there is no need to follow this step as the pump is default set to address #1.

To assign an IntelliFlo pump address (Set On the IntelliFlo Pump):

1. Press the **Start/Stop** button to stop the pump. Be sure that the green power LED is on and the pump is stopped.
2. Press the **Menu** button.
3. Press the **Up and Down** arrow buttons to scroll through the menu items. Press the **Select** button to access the "Pool Data" menu (IntelliFlo VF) or "Settings" menu (IntelliFlo VS).
4. Press the **Select** button to access the "Pump Address" setting.
5. Press the **Select** button to change the current pump address.
6. To enter the new address number, press the **Left** and **Right** arrows to select which digit to modify, then use the **Up** and **Down** arrows to change the selected digit.
7. When you are done assigning the pump address number, press the **Enter** button to save the changes. To cancel any changes, press the **Escape** button to exit edit mode without saving.

## Valves Menu

This feature lets you assign a circuit to Valve A or B. The EasyTouch system can drive two auxiliary valve actuators (A and B) for applications such as solar heating and water features. By assigning AUX circuits to control valve actuators, you can conserve auxiliary circuits for high voltage relays for controlling pumps and lights.

Valve A: Resides on the EasyTouch motherboard. If solar heating is setup and is not configured as a heat pump, then Valve A is dedicated for controlling the solar heating valve actuator. Solar is enabled in the "Solar" menu. The Valve A selection will display "USED SOLAR."

Valve B: Resides on the EasyTouch motherboard. Can be configured to be controlled by any circuit.

### Getting There

MENU ▼ SETTINGS ▼ VALVES ► SETUP VALVES

To assign a circuit to Valve A and Valve B:

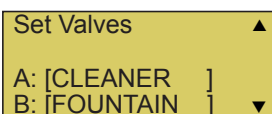

**Up/Down buttons:** Select a circuit to assign to **VALVE A**. The generic circuit names are: NONE, SPA, POOL, AUX 1-7 (EasyTouch PNP 10), AUX 1-3 (EasyTouch PNP 5), FEATURE 1-8, AUX EXTRA (or SOLAR) and HEATER. USED SOLAR is displayed when SOLAR is enabled from the Solar menu. AUX EXTRA is displayed only available if the Solar output (J17) plug on the EasyTouch motherboard is not being used for solar equipment. Use the Solar button to switch the extra circuit on and off. Selecting NONE does not assign a circuit.

**Right button:** Move to Valve B setting.

**Up/Down buttons:** Select a circuit to assign to Valve B. See above for the generic circuits names.

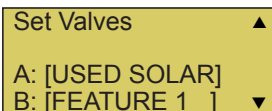

Press the **Menu** button to save the settings and to return to the Settings menu options. Press the button again to return to the main menu options or press again to return to the main screen.

# Programming EasyTouch: Schedules

## Schedules Menu

Use the Schedules menu to create programs to schedule start and stop times to automatically run equipment, such as pumps and lights. Any circuit can be programmed to switch on and off at a specific time on every or any specific day of the week. The number of programs that can be created for circuits are as follows:

- Up to 12 total programs can be created for all circuits combined.
- One circuit can have up to a maximum of 9 programs.

Using the Schedules menu

Use the Schedules menu features to program operating schedules for the pool, spa and auxiliary circuits:

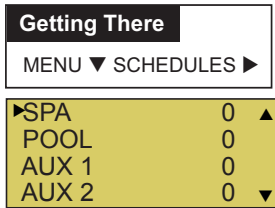

Choose the circuit to program

**Up/Down button:** Select the generic circuit name to program: Spa, Pool, Aux 1-7, Feature 1- 8, Aux 1-3 and Aux Extra. Aux Extra is only available if the Solar output is not being used. See Solar button on page 5 for details. The current number of programs for each circuit is displayed opposite the circuit name. A circuit can have up to 9 programs (9/9). Three additional programs can be assigned to another circuit or three separate circuits for a maximum of 12 programs.

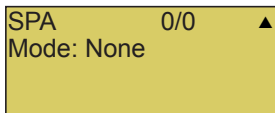

Create a new program

The current number of programs for each circuit is indicated opposite to the circuit name. 0/0 indicates no programs assigned to this circuit.

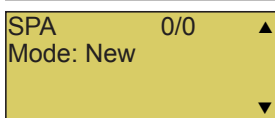

**Right button:** To move to the “Mode” selection.

**Up/Down button:** Select **New** to create a new program. Use “None” when a circuit has existing programs and you wish to exit the “Mode” selections without modifying the existing programs.

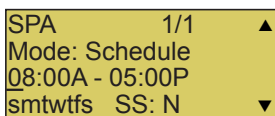

Choose the type (Mode) of program to run

After selecting “New” the current program number (1/1) for this circuit is displayed.

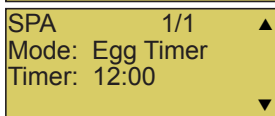

**Right button:** To move to the “Mode” selections.

**Up/Down button:** Choose the program to run: **Schedule, Egg Timer, Once Only, New, Delete, and None.** If there are existing programs assigned to this circuit, use these buttons to view and select the existing program settings.

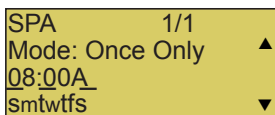

Mode Selection:

**Schedule:** Set start, stop times and the day(s) of the week to automatically switch pool/spa circuits on or off. Default run time for the “Schedule” feature is 8:00 AM to 5:00 PM. If you program the start and stop times the same the schedule is will run for 24 hours. Note: **SS: N (Smart Start)** is displayed if a light circuit is being scheduled (see page 45).

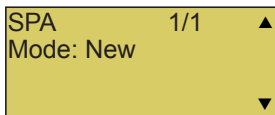

**Egg Timer:** A one time program that switches on a function at a specific time, and counts down the preset time to the switch off the function. After the “Egg Timer” schedule has finished, the system can be operated in manual mode. The “DON’T STOP” option allows a circuit to run continuously until its switched off manually.

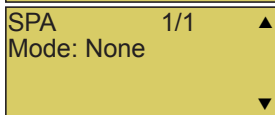

**Once Only:** Schedule a circuit to switch on at a particular time on a onetime basis.

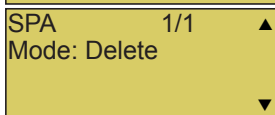

**New:** press the **Right** button to create a new program.

**Delete:** Select the program and press the **Right** button to delete it.

**None:** Press the **Right** button to exit the “Mode” selections without modifying the program.

## Schedules Menu (Continued)

Schedule your spa/pool pump to turn on

Use the Schedule feature to set the time and day(s) when to switch the filter pump on and rotate the pool or spa valves into the “Spa” or “Pool” position. The heater will automatically heat the spa or pool water up to the set point temperature as set in the “Heat” menu (see page 32). If the pool has a separate jet pump or blower controlled by AUX 1 and/or AUX 2 , these need to be scheduled separately.

### Schedule Example

When a circuit relay is switched on manually, it remains on until you either switch it off manually, or the next time the relay is scheduled to be switched off. For example, if the filter pump or any circuit is scheduled to run from 9:00 AM to 4:00 PM and the programmed schedule is turned OFF at 1:00 PM and then turned on at 1:10 PM, the circuit will turn OFF at its programmed OFF time of 4:00 PM. But if the circuit is turned on after 4:00 PM, the factory set Egg Timer of 12 hours is now engaged. So if the circuit was turned on at 6:00 PM that circuit will turn off at 6:00 AM (12 hours later). If the circuit was turned ON at 5:00 PM and because a programmed OFF time had been set to turn off at 4:00 PM, the circuit would operate for 11 hours. A spa or pool program can be overridden using the Spa button or Pool button to switch the circuit on. If you program the start and stop times the same, the schedule will run for 24 hours if scheduled to run for one day. In “Service” mode, a pool or spa program can be overridden using the Filter (F) button and pool/spa Valves (V) button on the outdoor control panel in the EasyTouch load center. **Note:** The following example describes how to use the “Schedule” feature to program the spa circuit to switch the filter pump on and rotate the valves into the “Spa” position and switch the heater on. This example can also be used to program when to filter and heat your pool, and switch light or auxiliary circuits on or off.

To create a schedule for your spa or pool pump to turn on:

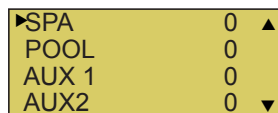
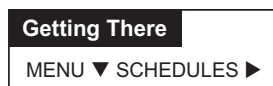

**Press the Up/Down button** to select the circuit to schedule then press the **Right button**.

**Right button:** Select **Mode** if there are existing programs. Skip this step to create a new program.

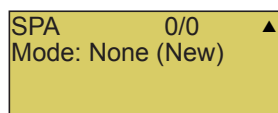

**Up/Down button:** Select **New** to create a new program.

**Right button:** To create a new program and enter the “Mode” settings.

**Up/Down button:** 1/1 indicates that this circuit has one program. If there are existing programs assigned to this circuit, use these buttons to view and select the existing program settings.

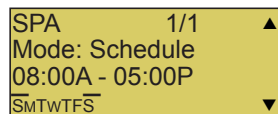

**Right button:** To select the “Schedule” settings.

**Right button:** Move to start and stop time settings.

**Up/Down and Right buttons:** Set start and stop hour (A/P), minutes.

The A (AM) and P (PM) time is set when setting the start and stop hour.

**Right button:** Move to days of the week to run the program.

**Right and Up/Down buttons:** By default the program is set to run all the days of the week. If you wish to edit which days to run the program, select the day of the week, then press the **Up/Down** button to remove the bar from the top of the letter. A bar on top of the letter indicates the day selected to run the program.

Press the **Menu** button to save the settings and to return to the Schedules menu options. Press the button again to return to the main menu options or press again to return to the main screen.

# Programming EasyTouch: Schedules

## Schedules Menu (Continued)

### Using the Once Only feature

The "Once Only" feature allows you to program a circuit to switch on at a particular time and day on a onetime basis. A typical use for this feature is to have the spa and heater switch on before you get home from work for one evening. Unlike the regular "Schedule" timer, this feature does not repeat. After this event has finished, the program is automatically erased. The circuit must be switched off manually or wait for the 12 hour automatic shut off. If you wish to override the 12 hour default shut-off time you can extend the time by using the "Egg Timer" countdown feature (page 38).

**Note:** The following example describes how use the "Once Only" feature to program the spa circuit to switch the filter pump on and rotate the valves into the "Spa" position and switch the heater on for one time only. This example can also be used if you wanted to program when to filter and heat your pool, and switch light or auxiliary circuits on.

The set a "Once Only Timer" program for the spa:

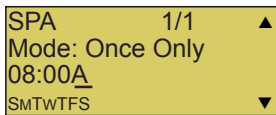
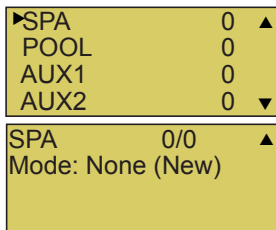

**Press the Up/Down button** to select the circuit to schedule then press the **Right button**.

**Right button:** Select **Mode** if there are existing programs. Skip this step to create a new program.

**Up/Down button:** Select **New** to create a new program.

**Right button:** To create a new program and enter the "Mode" settings.

**Up/Down button: 1/1** indicates that this circuit has one program. If there are existing programs assigned to this circuit, use these buttons to view and select the existing program settings.

**Right button:** To select the ONCE ONLY settings.

**Right button:** Move to start time settings.

**Up/Down and Right buttons:** Set the start hour (A/P) and minutes. A (AM) and P (PM) time is set when setting the start hour. Note: if the Start Time is set to an hour which has already passed, then the program will be executed the following day. Another day of the week may also be chosen. The stop time will be 12 hours later, or can be turned off manually. The 12-hour shut off can be changed to any length of time by entering another program using the "Egg Timer" program (page 38).

**Right button:** Move to day of the week to run the program.

**Right button:** Select which day to run the program then press the **Up/Down button** to enable the bar on top of the letter. A bar on top of the letter indicates the day selected to run the program.

Press the **Menu** button to save the settings and to return to the Schedules menu options. Press the button again to return to the main menu options or press again to return to the main screen.

**"Once Only" acts as if you switched it on manually - Use it with "Egg Timer" to control switch off time.**



## Using the Egg Timer (countdown) Feature

The “Egg Timer” feature allows you switch off a circuit automatically after a specified time. The time period is from one minute to 24 hours or run continuously. The “Egg Timer” (countdown) feature is useful for switching off lighting and spa therapy jets. For example, a jet pump can be setup to switch off in 15 minutes, even if you switch it on using the iS4 or iS10 Spa-Side remote control or whenever you switch your spa on, you would like it to automatically switch it off in two hours. All Egg Timer programs are factory set to switch off after 12 hours. You also have the option to use the “Don’t Stop” feature to run a circuit continuously until manually switched off.

In the event of a power failure, the “Egg Timer” feature will not switch the circuit back on. Use the “Service” mode to turn the equipment back on. Refer to “Mode button,” page 4 for more information. For running the filter pump continuously during new pool start up, it is recommended to use the “Service” mode, which will automatically restart the filter pump in the event of a power failure.

The following example describes how use the “Once Only” feature to program the spa circuit to switch the filter pump on and rotate the valves into the “Spa” position and switch the heater on for one time only. This example can also be used if you wanted to program when to filter and heat your pool, and switch light or auxiliary circuits on.

To set the Egg Timer feature:

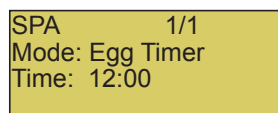
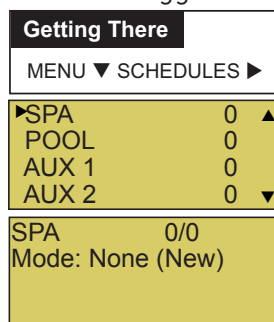

**Press the Up/Down button** to select the circuit to schedule then press the Right button.

**Right button:** Select **Mode** if there are existing programs. Skip this step to create a new program.

**Up/Down button:** Select **New** to create a new program.

**Right button:** To create a new program and enter the “Mode” settings.

**Up/Down button:** 1/1 indicates that this circuit has one program. If there are existing programs assigned to this circuit, use these buttons to view and select the existing program settings.

**Right button:** To select the “Egg Timer” settings.

**Right button:** Move to the time settings.

**Up/Down and Right buttons:** Set the hour and minutes for the program to run. The count down time can be set from 00:01 to 23:59 and Don’t Stop. The “Don’t Stop” feature allows the circuit to run continuously until manually switched off.

Press the **Menu** button to save the settings and to return to the Schedules menu options. Press the button again to return to the main menu options or press again to return to the main screen.

# Programming EasyTouch: Remote Controls

## iS4 Spa-Side Remote Controller

You can specify any iS4 Spa-Side remote button to control different functions by assigning each button to a specific circuit. For example, you can use the iS4 Spa-Side remote to activate the spa circulation and for operating auxiliary equipment such as heater, lights, jet pump, heat boost, air blower, waterfall, etc.). You can also use the "Pump Incrs" and "Pump Decrs" circuit to increase or decrease the pump speed for an IntelliFlo **VF (GPM)** or **VS (RPM)** pump. For example, if the "Pump Incrs" circuit is assigned to an iS4 button, each press of the button will increase the pump speed in specific speed increments as specified in the "10 B Pump Cntrl" menu setting (see page 50). Speed increments are set from 10 to 250 RPM (or 1 to 10 GPM, for the IntelliFlo VF).

To assign iS4 Spa-Side buttons:

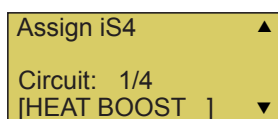

**Up/Down buttons:** Select a circuit to one of the iS4 buttons. You can set up to four circuits (1/4, 2/4, 3/4, 4/4).

**Right button:** Move to the circuit setting.

**Up/Down buttons:** To configure the first button on the iS4 Spa-Side Remote, scroll through the circuit names and find the circuit that you would like to assign to the first button on the iS4. The generic circuits are: **NONE, SPA, POOL, AUX 1-7 (EasyTouch PNP 10), AUX 1-3 (EasyTouch PNP 5), FEATURE 1-8, SOLAR (if selected in "Heat" menu), AUX EXTRA, HEAT BOOST, HEAT ENABLED, PUMP INCRS, PUMP DECRS**. Selecting "NONE" does not assign a circuit.

**Note:** The "HEAT BOOST" feature will switch on the heater for seven minutes to increase the spa water temperature. Each time the spa Heat Boost button is pressed, the temperature will increase about 1° C. The temperature will not go beyond the 40°C limit.

**Right button:** Assign the next circuit (2/4).

**Up/Down buttons:** Select the first digit for the circuit number (1/4, 2/4, 3/4, 4/4) and repeat the procedure for the other three buttons.

Press the **Menu** button to save the settings and to return to the Settings menu options. Press the button again to return to the main menu options or press again to return to the main screen.

## SpaCommand 10 Button Spa-Side Remote Controller

From this menu you can assigning a specific circuit to any one of the ten buttons of an iS10 and SpaCommand spa-side remote to control different pool/spa functions. The iS10 and SpaCommand has ten assignable circuit buttons; five button on the top row and five buttons on the bottom row. You can also use the "Pump Incrs" and "Pump Decrs" circuit to increase or decrease the pump speed for an IntelliFlo VF (GPM), VS (RPM) and VSF (RPM/GPM) pump. For example, if the "Pump Incrs" circuit is assigned to an iS10 button, each press of the button will increase the pump speed in specific speed increments as specified in the "10B Pump Cntrl" menu setting (see page 43). Speed increments are set from 10 to 250 RPM (or 1 to 10 GPM, for the IntelliFlo VF).

Assign 10 Button Spa Side Remote (iS10/SpaCommand)



Before configuring the 10 button spa-side remote controller (iS10/SpaCommand) assign names to the circuits (see page 30).

To assign an iS10 and SpaCommand spa-side remote buttons:

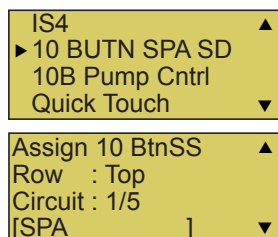

**Up/Down buttons:** Select the “Top” or Bottom” row to assign circuits to.

**Right buttons:** Select a circuit to one of the iS10 buttons. Five top row buttons can be assigned circuits (1/5, 2/5, 3/5, 4/5 and 5/5). See “iS10/SpaCommand button assignments” below for details.

**Right button:** Move to the circuit setting.

**Up/Down buttons:** To configure the first button on the iS10 Spa-Side Remote, scroll through the circuit names and find the circuit that you would like to assign to the first button on the iS4. The generic circuits are: **NONE, SPA, POOL, AUX 1-7 (EasyTouch PNP 10), AUX 1-3 (EasyTouch PNP 5), FEATURE 1-8, AUX EXTRA (or SOLAR if selected in “Heat” menu), HEAT BOOST and HEAT ENABLED.** Selecting “None” does not assign a circuit.

**Note:** The “Heat Boost” feature will switch on the heater for seven minutes to increase the spa water temperature. Each time the spa Heat Boost button is pressed, the temperature will increase about 1° C. The temperature will not go beyond the 40° C limit.

**Right button:** Assign the next circuit (2/5).

**Up/Down buttons:** Select the first digit for the circuit number (1/5, 2/5, 3/5, 4/5) and repeat the procedure for the other three buttons.

Press the **Menu** button to save the settings and to return to the Settings menu options. Press the button twice to return to the main screen.

## 10 Button Pump Cntrl

From this menu setting you can specify the IntelliFlo VS, VF and VSF pump speed (RPM, GPM) in step increments, for the assigned iS4, iS10 or SpaCommand button using the “Pump Incrs” or “Pump Decrs” circuit. For example, the “Pump Incrs” and “Pump Decrs” circuit can be assigned to any two iS10 buttons. Each press of the assigned “increase” button will increase the pump speed in specific speed increments, as specified in the “iSx Pump Cntrl” menu setting. Speed increments are set from 10 to 250 RPM or 1 to 10 GPM.

Before setting the pump step speed, be sure to specify the IntelliFlo pump number and type in the IntelliFlo menu (“Pump #1, Pump #2,” Pump Type), see page 34.

### Getting There

MENU ▶ SETTINGS ▶ 10B PUMP CNTRL

To set a pump step speed:

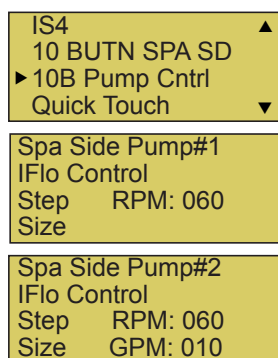

**Up/Down buttons:** Select the “Pump Number” as specified in the IntelliFlo menu (see page 32).

**Right buttons:** Select the pump “Step” speed (RPM/GPM).

**Up/Down buttons:** Adjust the “Step” pump speed. Settings are:

- IntelliFlo VS: 10 to 250 RPM
- IntelliFlo VF: 1 to 10 GPM.

Press the **Menu** button to save the settings and to return to the Settings menu options. Press the button twice to return to the main screen.

# Programming EasyTouch: Remote Controls

## QuickTouch (QT4) Wireless Remote

The QuickTouch QT4 wireless remote controller provides switching of up to four circuits. For example, you can use the QT4 wireless remote to activate the spa circulation, and for operating three auxiliary pieces of equipment (such as heat enabled, lights, jet pump, heat boost, air blower, waterfall, etc.).

Each of the four functions on the QT4 wireless controller has an on and an off button. To switch a circuit on or off, press and hold the appropriate button for at least a full second.

The QT4 buttons can be assigned to any available circuit. However, the QT4 has the following preset circuits assigned to the four buttons:

- Spa button activates the spa circuit.
- A button activates **Auxiliary 1** circuit.
- B button activates **Auxiliary 2** circuit.
- C button activates **Auxiliary 3** circuit.

### Getting There

MENU ▼ SETTINGS ▼ QUICKTOUCH ► ASSIGN QT4

To assign circuits to the QuickTouch wireless controller buttons:

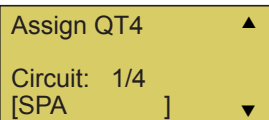

**Up/Down buttons:** Select a circuit to assign to one of the QuickTouch wireless remote buttons. You can set up to four circuits (1/4, 2/4, 3/4, 4/4).

**Right button:** Move to the circuit setting.

**Up/Down buttons:** To configure the first button (1/4) on the QuickTouch wireless remote. Use these buttons to scroll through the circuit names and find the circuit that you would like to assign to the first button. The generic circuits are: **NONE, SPA, POOL, AUX 1-7 (EasyTouch PNP 10), AUX 1-3 (EasyTouch PNP 5), FEATURE 1-8, AUX EXTRA (or SOLAR if selected in "Heat" menu), HEAT BOOST and HEAT ENABLED.** Selecting "None" does not assign a circuit.

**Note:** The "Heat Boost" feature will switch on the heater for seven minutes to increase the spa water temperature. Each time the spa Heat Boost button is pressed, the temperature will increase about 1°C. The temperature will not go beyond the 40°C limit.

**Right button:** Assign the next circuit (2/4).

**Up/Down buttons:** Select the first digit for the circuit number (1/4, 2/4, 3/4, 4/4), then repeat the procedure for the other three buttons.

Press the **Menu** button to save the settings and to return to the Settings menu options. Press the button again to return to the main menu options or press again to return to the main screen.

## Advanced Settings

### Setting up lights

From the Lights screen you can manually switch all lights on or off, synchronize coloured lights, and activate colour light shows. Up to eight (EasyTouch PNP 10) or four (EasyTouch PNP 5) light circuits can be configured from the “Config” light menu. Each light must have its own relay and separate circuit.

### Setting up IntelliBrite Light Circuits

Before configuring the lights, be sure the auxiliary (AUX) circuits that control the IntelliBrite lights have been assigned as an “IntelliBrite” light. For more information about “Circuit Functions” (page 30) and “Circuit Names,” (page 28).

Globrite, Colorcascade, MagicStream\* and ColorVision lights all use the IntelliBrite program.

\*MagicStream laminars can be configured as either IntelliBrite or MagicStream. Refer to the MagicStream instruction manual for details on setting mode.

### Lights Menu

To access the Lights menu screen, press Menu > Lights.



The Lights menu settings are: MODES, COLORS, ALL ON, ALL OFF, SYNC, MAGICSTREAM, CONFIG:

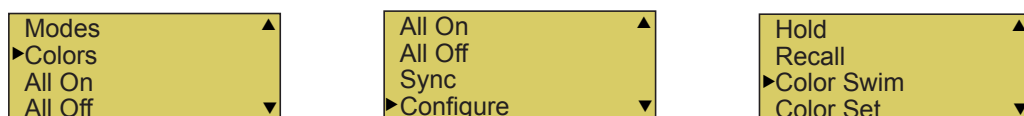

Modes (IntelliBrite Color light shows, Color Swim, Color Set)

To access the Modes menu, press **Menu > Lights > Modes**. There are six pre-programmed colour light shows to choose from. From the “Modes” screen you can select various preset show colour lighting effects, such as “American mode” and “Sunset mode”, “Color Swim” or “Color Set.” Using the “Hold” and “Recall” feature you can also capture and save a unique colour light show effect to recall at a later time.

The IntelliBrite colour “Mode” settings light shows are:

- **Party:** Rapid colour changing building the energy and excitement
- **Romance:** Slow colour transitions creating a mesmerizing and calming effect
- **Caribbean:** Transitions between a variety of blues and greens
- **American:** Patriotic red, white and blue transition
- **Sunset:** Dramatic transitions of orange, red and magenta tones
- **Royalty:** Richer, deeper, colour tones

If the IntelliBrite light was not previously on, after selecting a colour show mode, no illumination will occur for up to ten (10) seconds (depending on the selection), then a white light will momentarily illuminate, followed by the colour show mode selection. If the light was previously on, selecting the a colour show mode button will momentarily illuminate the previously selected colour before changing to the selected colour show.

### Modes (Color Swim)

The Color Swim feature cycles through white, magenta, blue and green colours. Using IntelliBrite lights, Color Swim creates an effect of swimming through a beam of colour. Use config screen to set light positions so that tis feature may work. i.e. beam of colour will advance from position 1 to 2 to 3 to 4 and so on.

# Advanced Settings: Lights

## Setting up lights (Continued)

### Modes (Color Set)

The “Color Set” feature allows any combination of up to eight (EasyTouch PNP 10) or four (EasyTouch PNP 5) IntelliBrite lights, and SAm, SAL and or Fiberworks lighting to be preset to specific colours. Fixed light colours are selected and activated from the Colors screen.

**IntelliBrite Light:** If the light was not previously on, after selecting the fixed coloured light, no illumination will occur for approximately six (6) seconds followed by the selection. If the light was previously on, after selecting the coloured light, the previously selected colour will momentarily illuminate, no illumination will occur for approximately six (6) seconds followed by the selection.

### Colors

Choose any one of the five fixed colours to create a spectacular underwater lighting effect. The fixed colours are: **Blue, Green, Red, White** and **Magenta**. You can switch each fixed coloured light on or off from the Colors screen.

**IntelliBrite Light:** If the light was not previously on, after selecting a fixed coloured light, no illumination will occur for up to ten (10) seconds (depending on the selection), then a white light will momentarily illuminate, followed by the colour selection. If the light was previously on, selecting the a colour button will momentarily illuminate the previously selected colour before changing to the selected colour.

To select a fixed color press: Menu > Lights > Modes > Colors:

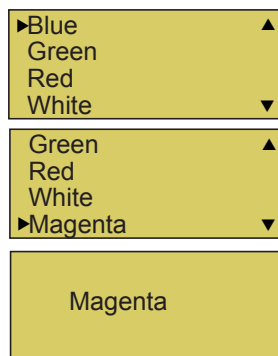

**Up/Down buttons:** Choose a colour for the light.

**Right button:** Switch the selected coloured light ON. To switch the light off, go to the main Lights menu and select **All Off**, or press the AUX button assigned to the light. The AUX button will also switch the light on. Press the **Menu** button three times to return main menu.

**⚠ WARNING - IntelliBrite Lights:** During the off/on switching process, before the selected colour is displayed, no illumination will occur. This operating mode is normal during the switching process. During this period the pool and spa will be dark and precautions should be taken to avoid unforeseen accidents. Failure to observe this warning may result in serious injury or death to pool and spa users.

### Hold/Recall

Select Hold and Recall from the “Modes” or “Color” screen to capture and save a unique colour effect and recall it at a later time. For example, while a light show (Romance Mode) is active, select “Hold” to save the exact colours that are being displayed, then later, to recall the exact colour effect, select “Recall.”

**Note:** After selecting Hold or Recall, no illumination will occur for up to 10 seconds, then a white light will momentarily illuminate, followed by the saved colour.

### All On / All Off (Lights Menu)

Select **All On** or **All Off** from the Lights screen to manually switch all lights on or off, including any MagicStream laminar circuits. Press the control panel auxiliary button (AuxX) assigned to a light circuit will also switch a light on or off.

### Sync

Select **Sync** from the “Lights” screen to synchronize colours for all IntelliBrite, SAm, SAL and FIBERworks colour changing lights.

## Setting up lights (Continued)

### Config

From the “Config” screen you can setup the IntelliBrite light position, and specify the colour of each pool and spa light. Any combination of up to eight (EasyTouch PNP 10) or four (EasyTouch PNP 5) IntelliBrite lights, SAM, SAL and or Fiberworks lights can be preset for specific colours and position when using the “Color Swim” and “Color Set” feature. Fixed light colour are selected and activated from the Colors screen. Note: The “Config” menu settings do not apply to the MagicStream laminars.

To select configure a light position and color: Menu > Lights > Config:

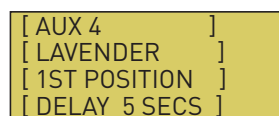
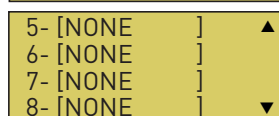
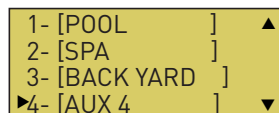

**Up/Down buttons:** Choose the light circuit (1-8) to configure. Select an available auxiliary circuit (NONE). For more about assigning an auxiliary circuit to a light, see “Circuit Functions (page 30) and “Circuit Names” (page 28). EasyTouch PNP 10 supports up to eight (8) auxiliary circuits, EasyTouch PNP 5 supports up to four (4) auxiliary circuits.

**Right button:** Select the light to setup.

**Up/Down buttons:** Select the light circuit.

**Right button:** Move to the light colour selection.

**Up/Down buttons:** Select the light colour (**Blue, Cyan, Green, Lt. Green, White, Lt. Magenta, Magenta, Lavender**).

**Right button:** Move to the light position selection.

**Up/Down buttons:** Select the light position. A light can be assigned to any position from 1 through 12. To ensure that the “Color Swim” and “Color Set” lighting feature colour effects are correct, set the position of the light according to where it’s located in the pool or spa. **Position 1** will lead all the other lights in the colour changing sequence. **Position 2** follows Position 1 and so on. There are 12 position to choose from. More than one light may be assigned to the same position number so that their colours may be synchronized. For example, to make the colours swim right to left, make your right most light Position 1. You may need to go back to and scroll through your lights to find the right most light, and set it as Position 1.

**Right button:** Move to the light delay selection. The Delay time between two or more lights can be set from 0 to 60 seconds. Use a higher delay time for lights spread further apart. Try five seconds for all lights and observe the effect. Use different time settings to achieve unique lighting moods and effects.

Press the **Menu** button to setup other lights or press Menu button four times to return main screen.

**Smart Start** (SS: Yes/No) - Select Smart Start in the Schedules menu (see page 27). The Smart Start feature automatically starts changing colours when the lights are programmed to switch on. Smart Start is used when Color Swim and IntelliBrite show modes are being used.

# Advanced Settings: Lights

## Setting up MagicStream Laminars

The MagicStream® Laminar provide a clear, turbulence-free stream of water that is lit with a fiber optic cable, or an LED light for a dazzling nighttime effect. The 12 VAC powered LED light can generate a series of multicoloured light shows, or can be set to display a continuous, single colour. If desired, the built-in solenoid “thumper” can create a random “wrinkle,” in the Laminar’s stream, causing it to display a brilliant spot of light that moves along the stream’s arc. The light enhancer can be adjusted to maximize the light in the arc.

Up to twelve (12) MagicStream Laminar circuits can be displayed on the main Lights screen, assuming each laminar has its own relay and separate circuit.. From the Lights screen you can activate the MagicStream laminars (changing colour modes, turn Thumper on/off, Hold and Reset).

MAGICSTREAM LAMINARS CAN BE CONFIGURED AS EITHER INTELLIBRITE OR MAGICSTREAM. REFER TO THE MAGICSTREAM INSTRUCTION MANUAL FOR DETAILS ON SETTING MODE.

## Setting up MagicStream Laminar LED Lights

To setup MagicStream laminar circuits, first assign each laminar auxiliary relay circuit a circuit name (see “Circuit Names” page 28, then assigned the laminar relay circuit name to “MAGICSTREAM” in the circuit functions menu (Circuit Func.).

## Using the MagicStream Laminar Features

The MagicStream laminar features are displayed in the MagicStream menu. Each time a MagicStream laminar feature is activated, it resumes with the same features in operation as when last switched off. The MagicStream features are as follows:

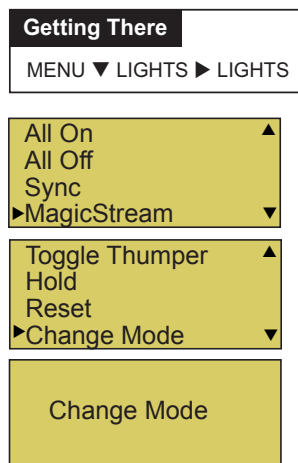

**Down button:** Choose MagicStream.

**Right button:** Select **MagicStream**.

**Up/Down button:** Select the desired MagicStream laminar features.

**Right button:** Use this button to activate the selected MagicStream laminar feature. After the button is pressed, the following screen displays the name of the selected feature (indicating that the MagicStream feature has been activated) then returns to the MagicStream feature menu.

Toggle Thumper - Pressing this button creates a “wrinkle” in the laminar stream, producing a brilliant spot of light in the laminar arc.

Hold - Select Hold to capture the current colour effect while colours are changing. The colours will stop changing. Selecting Hold again will resume the colour changing mode.

Reset - Pressing this button reverts to the **Random** colour changing mode with the Thumper ON.

Change Mode - Pressing this button (each successive OFF/ON combination) will cycle through **Sync**, **Random** and **Party**. Colour changing mode - The colour of the light changes automatically, according to one the following three programs:

Sync - Colours will change at ten second intervals. In this mode, multiple laminars will synchronize colours together. Note: To sync multiple laminars (two or more AUX circuits), be sure to define the “MagicStream” circuits in the “Circuit Functions” menu.

Random - Colours will change at ten (10) second intervals in a random sequence. In this mode, multiple laminars will NOT synchronize colours together.

Party - Colours will change randomly and slowly at first, then speed up, until the sequence ends with quick flashes and strobes. The sequence then repeats, beginning with the slow changes. In this mode, multiple Laminars will NOT synchronize colours together.



## Feature Circuits

There are eight (8) "Feature Circuits" that can be used to control IntelliFlo pump speeds or valves actuators for a spa spillway. Unlike an auxiliary relay circuit, a "Feature" circuit does not connect directly to a relay. "Feature" are turned on and off from the control panel "Feature" circuit menu.

Feature Circuits



To switch a feature circuit ON or OFF:

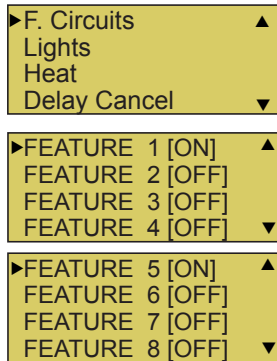

**Right button:** Select the feature circuit to turn ON or OFF..

**Up/Down buttons:** Choose assigned feature circuit: FEATURE 1 - 8.

**Right button:** Switch the selected feature circuits ON or OFF.

When finished, press the **Menu** button twice to return to the main screen.

# Advanced Settings: Delays

## Delays

Setup which functions (pool/spa, and valves) to assign the delay feature. Delays can be assigned to the following equipment.

- **Heater Cool-Down Delay Cancel:** Shuts Filter Pump off immediately.
- **2-Speed Filter Pump five-minute START on HIGH SPEED Delay Cancel:** Shifts pump to low speed.
- **Automatic Pool Cleaner START Delay:** Starts Cleaner Pump immediately, without normal delay in which the filter pump first runs for 5 minutes.
- **Automatic Pool Cleaner SOLAR Delay:** Allows Cleaner Pump to run even though solar delay has shut it off for 5 minutes.

Some heaters require a cool down cycle before being switched off. This can be setup to run the filter pump an additional ten minutes to dissipate residual heat built up inside the heater combustion chamber. You can also cancel the delay feature.

To assign a delay feature:



Press the **Up/Down buttons** to select **YES to enable COOLDOWN** delays for the pool and spa circuits. Select **YES** to use delays for valves. Press the **Menu** button to save and to return to the Settings menu options.

### Delay Cancel Menu

Use the Delay Cancel feature for service or testing purposes. For convenience, on a onetime basis, the Delay Cancel feature will cancel the above safety delays. Please note, generally there is no need to cancel any of the above delays except for servicing or testing the system.

To activate Delay Cancel:



**Up/Down button:** Select Delay Cancel.

**Right button:** Use this button activate Delay Cancel for one time only. "Delay Cancelled" is displayed after pressing the Right button.

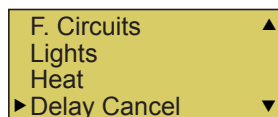

Press the **Menu** button to return to the main screen.

### Heat Pump COM (UltraTemp® Heat Pump)

The Pentair UltraTemp Heat Pump is currently unavailable in Australia and New Zealand. Other brand heat pumps still be used with the EasyTouch though. Refer to Page 18 for heat pump connection and configuration.

## IntelliChlor

While the EasyTouch system is in normal operating mode ("Pool," "Spa" mode or "Spa Fill (Spillway)," it will control the IntelliChlor chlorine output level. The amount of chlorine introduced into the pool is determined by the amount of salt in the water, water temperature, and the amount of time the pool pump is running in "Pool" mode. Note: While in "Freeze Protection" mode, IntelliChlor will not operate or produce chlorine during the time that the filter pump is operating. For more information, refer to the IntelliChlor Electronic Chlorine Generator User's Guide.



To setup the IntelliChlor:

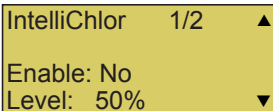

**Right button:** Enable/Disable IntelliChlor. (To select SuperChlor, run hours, press the **Up/Down** button - 2/2).

**Up/Down buttons:** Select **Yes** or **No** to enable or disable IntelliChlor.

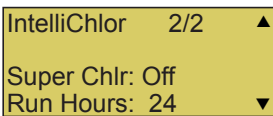

**Right button:** POOL Mode "50%" setting.

**Up/Down buttons:** Set the chlorination output level for the pool water from 0 to 100%. EasyTouch will determine the chlorinator output level when the system is operating in "Spa" or "Pool" mode. The amount of chlorine introduced into the pool/spa is determined by the amount of salt in the water, water temperature, and the amount of time the pool/spa operates in these modes mode.

**Right button:** SPA Mode "0%" setting.

**Up/Down buttons:** Set the chlorination output level for the spa water from 0 to 20%. To prevent over chlorination of the spa, the EasyTouch system will automatically drop the chlorine output levels to 1/20th of the current pool output when the spa is switched on. For example, if the pool output level is set to 60%, when the spa is switched on, the chlorination level is reduced to 3%.

**Right button:** Move to the next set of settings (2/2).

**Up/Down buttons:** Select 2/2.

**Right button:** Move the Super Chlorination settings.

**Up/Down buttons:** Set Super Chlorination **On** or **Off**. See note below about Super Chlorination.

**Right button:** Move to "Run Hours" setting.

**Up/Down buttons:** Set the number of hours to run Super Chlorination. 24 hours is the default setting. Run hours can be set from 0 to 72 hours.

Press the **Menu** button to save the settings and to return to the Settings menu options. Press the button again to return to the main menu options or press again to return to the main screen.

## Salt Chlorinator Connection (Other than IntelliChlor)

1. Connect the supply cord to the salt chlorinator's power pack to the EasyTouch outlet marked "Filter Pump".
2. If using a single speed pump, connect the pump to the outlet on the salt chlorinator's power pack marked "Pump". If using an IntelliFlo pump, the pump should be on 15A permanent power and controlled via the comm cable.
3. Set the salt chlorinator to "Manual" or "Override" to disable the power pack's timer.

# Advanced Settings: IntelliChem

## IntelliChem®

IntelliChem provides the EasyTouch system with continual analysis of your swimming pool water sanitation and pH levels, providing real-time status information to dispense the proper amount of muriatic acid (pH reducer) and chlorine or bromine for the correct sanitization and pH balance. IntelliChem operates with or without a salt chlorine generator to provide a self-replenishing supply of chlorine generated from salt. For more information, refer to the IntelliChem Installation and User's Guide.

From the IntelliChem menu you can adjust the pH and Oxidation Reduction Potential (ORP) set point values to meet pool and spa chemistry standards for your pool. A status screen displays a user adjustable pH and OPR fuel gauge which visually represents the same amount of chemicals available in pH and ORP container.

### Getting There

MENU ► SETTINGS ► INTELLICHEM

To access the IntelliChem pH and ORP settings:

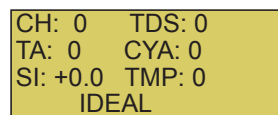
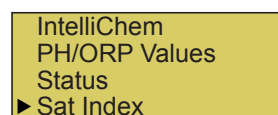
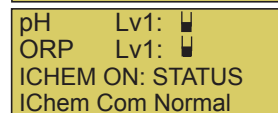
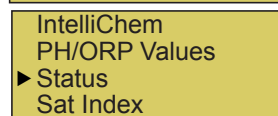
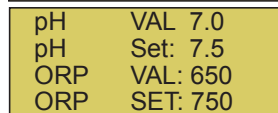
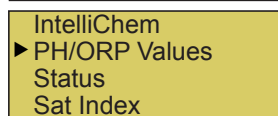
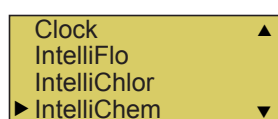

**PH/ORP Values:** Press the **Right button** to access the pH and OPR set point values screen. Use the **Up/Down** button to adjust the pH set point value. Press the **Right button** again to set the ORP set point value. Press **MENU** to save and return to the previous screen.

**pH Set Point:** Displays the current pH set point value. The adjustable range is from 7 to 8 in increments of 0.1. The default pH set point value is 7.5.

**ORP Set Point:** Displays the current ORP set point value. Use the **Up/Down button** to adjust the ORP set point value. The adjustable range is from 650 to 800 in increments of 10. The default ORP set point value is 700 (chlorine level of 3.0 ppm). The ORP set point is the value that IntelliChem will try to achieve based on the actual chlorine level (ppm).

**STATUS:** Displays the current communication link between EasyTouch and IntelliChem via the RS-485 cable. **IChem Comm Error:** Check the RS-485 communication cable is connected to the COM port on the EasyTouch circuit board.

**Level Gauge indicator:** Press the **Up/Down button** to “fill” the gauge icon so that it visually represents the same amount of acid available in the container. Press Up/Down button six (6) times to fill the gauge (three times to half fill the gauge). Six horizontal bars represent chlorine (or bromine) supply is full. One bar indicates the supply is nearly empty.

**Sat Index:** To access the Sat Index settings, press the **Up/Down button** then press the **Right button**. Use the **Up/Down button** to adjust the levels/values for: **CH (calcium hardness), TDS (Total Dissolved Solids), TA (total alkalinity), CYA (cyanuric acid) and TMP (current temperature).** **Note: See table below for ideal Saturation Index levels.**

**SI:** The saturation Index is displayed. IDEAL: Optimum levels. CORROSIVE: pH too low. SCALING:

Press the **Menu** button three times to return to the main screen.

**Note:** Use the **Langelier Saturation Index (LSI)** Calculator to diagnose the water balance in your pool. Water with a LSI of 1.0 is one pH unit above saturation. Reducing the pH by one unit will bring the water into equilibrium. To learn more about the LSI calculator refer to your IntelliChem owner's manual.

### Recommended Pool Chemistry

pH range:	7.2 to 7.6
ORP range:	650 to 750
Alkalinity:	80 to 120 ppm
Calcium Hardness:	200 - 500 ppm
Cyanuric Acid/Stabilizer:	30 ppm

## Settings Menu: 2-Speed Pump

Equipment circuits selected in this menu will automatically switch a two-speed filter pump to high speed when these circuits are on. If a two-speed pump is assigned to solar, a cleaner or a pump, when activated the pump will automatically run for five minutes in high speed then switch to low speed. For example, when on, the filter pump will switch to high speed whenever the JETS or CLEANER is on. There must be a two-speed relay installed in the EasyTouch Load Center in order for the "2-Speed Pump" menu settings to function.

### Getting There

MENU ▼ SETTINGS ▼ 2-SPEED PUMP ►

To configure a two-speed pump to a circuit:

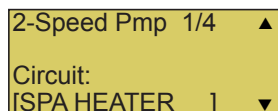

**Up/Down buttons:** Select a circuit that will switch the filter pump to high speed. You can set up to four circuits to use a two-speed pump (1/4, 2/4, 3/4, 4/4).

**Right button:** Move to assign a circuit setting.

**Up/Down buttons:** Select the circuit to assign to a two-speed pump. The generic circuits names are: **NONE, SPA, POOL, AUX 1-7 (EasyTouch PNP 10), AUX 1-3 (EasyTouch PNP 5), FEATURE 1-8, SOLAR, HEATER, POOL HEATER, SPA HEATER and FREEZE.** AUX EXTRA is displayed only available if the Solar output (J17) plug on the EasyTouch motherboard is not being used for solar equipment. Use the Solar button to switch the extra circuit on and off (see page 5). Selecting NONE does not assign a circuit. Note: You can use a Feature circuit to change a 2-Speed pump to high speed.

**Right button:** Assign the next circuit (2/4).

**Up/Down buttons:** Select the first digit for the circuit number (1/4, 2/4, 3/4, 4/4).

**Right button:** Move to circuit setting.

**Up/Down buttons:** Select the next circuit. When finished press the **Menu** button. Press the **Menu** button to save the settings and to return to the Settings menu options. Press the button again to return to the main menu options or press again to return to the main screen.

# Advanced Settings: Man Heat

## Getting There

MENU ▼ SETTINGS ▼ MAN HEAT (On/Off)

10B Pump Cntrl ▲  
QuickTouch  
Man Heat [On]  
Calibration ▼

## Getting There

MENU ▼ SETTINGS ▼ CALIBRATION ► CALIBRATION

Calibration ▲  
Water: 20°C  
Air: 25°C  
Solar: 45°C ▼

## Erase EEPROM (Erase System Memory)

EasyTouch system configuration data is stored and retained in “Flash” memory in an EEPROM located on the control panel motherboard and optional Indoor Control Panel. The EasyTouch user system configuration data can be erased to restore the factory defaults settings. System information automatically downloads from programmed components to non-programmed components in case of accidental memory loss and to ease board replacement. Any optional controllers (iS4, SpaCommand and QuickTouch QT4 controller) that were configured need to be reconfigured.

### Erase EEPROM

The following procedure describes how to erase the system memory from either the main EasyTouch control panel or the EasyTouch Indoor Control Panel.

**CAUTION:** This procedure will erase all system settings. Any optional controllers will need to be reconfigured.

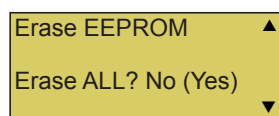

**Up/Down button:** Select **Yes**.

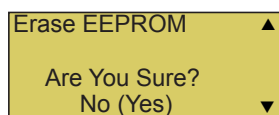

**Right button:** The message “**Erase EEPROM Are You Sure? No**” is displayed.  
**Up/Down button:** Select **Yes**.

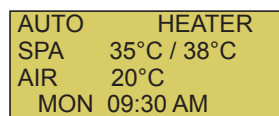

**Right button:** Press this button to erase system data and restore the factory defaults. The display will go blank, then the main screen will be displayed.

## Set Password

If required, the password feature allows you to password protect the EasyTouch control panel. To access a password protected control panel, you must enter the correct four digit password before access is granted.

### Password

To enable the password protect feature:

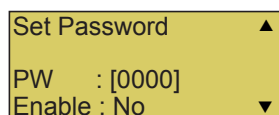

**Up/Down button:** Select the password **first** digit (0-7) of the four digit password.

**Right button:** Select the next password digit. Repeat the previous step to enter each of the password digits.

**Right button:** After you are finished entering the four password digits, press the Right button to enable the password feature.

**Up/Down button:** Select **Yes** enable the password feature.

Press the **Menu** button three times to save the settings and to return to the main screen.

**Note:** If the password feature is enabled, the current four digit password can be viewed from the EasyTouch outdoor control panel in the “Set Password” setting.

# Advanced Settings: EasyTouch Wireless

## Wireless Addr

Use this feature to assign the EasyTouch wireless control panel a unique communication address to allow the wireless device to operate with the EasyTouch outdoor control panel.



### Setting up the EasyTouch wireless control panel for the first time

Setting up the EasyTouch wireless control panel

In order for the EasyTouch wireless control panel to communicate with the EasyTouch system outdoor control panel, the first time the wireless device is powered up it must first be assigned a unique communication address. For this process you need to access the menu for each control panel. For convenience it's easier to setup the wireless device at the outdoor control panel.

From the EasyTouch load center outdoor control panel

1. Switch power on to the EasyTouch load center.
2. Press **Menu** button, and select **Settings > Address** and press the **Right** arrow button.

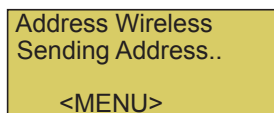
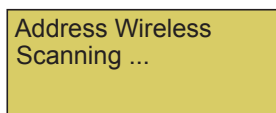

The EasyTouch outdoor control panel will display “Scanning...” for about five seconds while it searches for the EasyTouch wireless device within range of the transceiver antenna. After the scanning process has finished, “Sending Address” is displayed. The system is now waiting to lock on to the EasyTouch wireless control panel. Proceed to step 3.

From the EasyTouch wireless control panel

3. Press the **Power On** button located on the front of the wireless device.  
**Note:** After replacing depleted batteries a check battery message is displayed on the screen. Press the MENU button twice to continue.
4. Press **Menu** button, and select **Settings > Address** and press the **Right** arrow button.
5. Select “Address” and press the Right arrow button to lock on to the unique address that is being transmitted from the outdoor control panel.

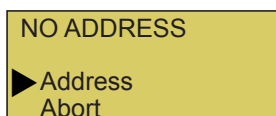

**Note:** If you choose “Abort,” the device can continue to operate using the factory default address. If the outdoor control panel has been previously addressed, the wireless may not operate the system. Each time the device is switched on the “NO ADDRESS” will be displayed. This mode is not recommended for permanent use.

6. After selecting “Address” the wireless device unit will lock on to a unique address and display “Found ADDRESSED.” Press the **Menu** button to save and exit this mode. The device is ready for operation.

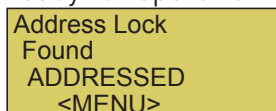

**Note:** “Unit Mismatch” displays if the outdoor control panel has an existing system image.

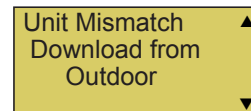

7. **On the outdoor control panel:** Press the outdoor control panel MENU button three times to exit the “Sending Address” mode and return to the main screen. The system will continue to transmit an address until the Menu is button is pressed to stop the process.

**Note:** To readdress the EasyTouch wireless device, repeat steps 2 through 7 on the wireless device to restart the address process.



## Synchronizing control panels

If the EasyTouch outdoor control panel was previously setup with specific pool and spa information and an additional indoor or wireless control panel with factory default information is installed, during the installation process the outdoor control panel will automatically download the system information to the connected control panel. If the outdoor, indoor or wireless control panels have different revision levels or contain previous setup information, you can choose which system image to upload or download.

Synchronizing control panels is initiated from the indoor or wireless control panel. The following describes how to synchronize an indoor or wireless control panel.

### Download from outdoor to indoor control panel

- Press the **Menu** button to download the system image from the EasyTouch outdoor control panel.



### Upload to outdoor from indoor control panel

1. Press the **Up/Down** button to access the "Upload" screen.
2. Press the **Menu** button to upload the system image from the indoor or wireless control panel to the EasyTouch outdoor control panel.



**Note:** To erase existing control panel system information, use the "Erase EEPROM" feature. Refer to "Erase EEPROM" on page 55 for more information.

# Diagnostics

## Spa Side [Off/On]

Enable or disable the iS4 Spa Side remote. This feature is useful for families with young children or when you go on vacation. It allows you to switch off the iS4 Spa Side remote at the control panel so that the remote cannot be used.

Spa Side



To enable or disable the iS4 Spa Side remote:

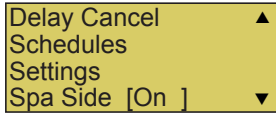

**Right button:** Select **On** or **Off** to enable or disable the spa side remote. Press the **Menu** button to save the settings and to return to the main screen.

## Diagnostics Menu



### Software Rev

Displays the current software revision for the EasyTouch main control panel and the optional indoor control panel.

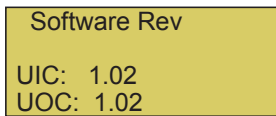

**UIC:** Displays the current software revision level for the indoor control panel.  
**UOC:** Displays the current software revision level for the outdoor control panel.  
Press the **Menu** button to return to the Settings menu options. Press the button again to return to the main menu options or press again to return to the main screen.

### Bootloader Rev

Displays the current bootloader revision for the indoor control panel and the main EasyTouch control panel.

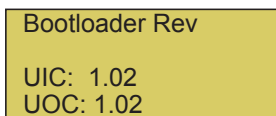

**UIC:** Displays the current bootloader revision level for the indoor control panel.  
**UOC:** Displays the current bootloader revision level for the outdoor control panel.  
Press the **Menu** button to return to the Settings menu options. Press the button again to return to the main menu options or press again to return to the main screen.

## Diagnostics Menu: Chlorinator

Displays the current IntelliChlor chlorination system status. For more information, refer to the IntelliChlor Electronic Chlorine Generator User's Guide (P/N 520589).

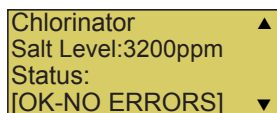

**Menu:** Press this button to return to the Settings menu options. Press the button again to return to the main menu options or press again to return to the main screen.

**SALT LEVEL:** Displays the current salt level. Values from 0 to 12750 ppm in 50 ppm increments.

IntelliChlor Status messages:

**SUPER CHLORINATE:** IntelliChlor is in "Super Chlorination mode (see page 35 for details)

**COM LINK ERROR:** Check cable from IntelliChlor to EasyTouch motherboard.

**Check FLOW/PCB:** Check IntelliChlor electrolytic cell controller. Refer to IntelliChlor User's Guide troubleshooting information.

**LOW SALT:** Add salt to pool water. The water salt level is between 2500 ppm and 2900 ppm. The IntelliChlor will continue to produce chlorine at a reduced level.

**VERY LOW SALT:** Not enough salt in pool. The water salt level has fallen below 2500 parts per million (ppm). IntelliChlor will not produce chlorine until additional salt is added manually.

**HIGH CURRENT:** Check IntelliChlor electrolytic cell controller. Refer to IntelliChlor User's Guide troubleshooting information..

**CLEAN CELL!!:** Cell has calcium build up and requires cleaning. Refer to IntelliChlor User's Guide for cleaning instructions.

**LOW VOLTAGE:** Check IntelliChlor electrolytic cell controller. Refer to IntelliChlor User's Guide troubleshooting information.

**OK - NO ERRORS:** IntelliChlor is in normal operating mode.

## Water Temp

Displays the current water temperature for the pool and spa.

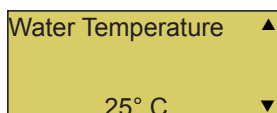

Press the **Menu** button to return to the Settings menu options. Press the button again to return to the main menu options or press again to return to the main screen.

## Solar Temp

Displays the current solar temperature.

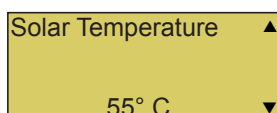

Press the **Menu** button to return to the Settings menu options. Press the button again to return to the main menu options or press again to return to the main screen.

# Diagnostics

## Diagnostics Menu: Air Temp

Displays the current outside air temperature.

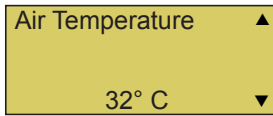

Press the **Menu** button to return to the Settings menu options. Press the button again to return to the main menu options or press again to return to the main screen.

## Cir Name: [Off/On]

This feature is useful if you have renamed many circuits and want to view the original factory default circuit names.

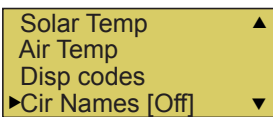

To enable:

**Right button:** Select **On** to view the factory default circuit names.

Press the **Menu** button to exit.

To disable:

**Right button:** Select **Off** to disable the feature.

Press the **Menu** button to exit.

## Reset System

Re-initialise the Outdoor Control Panel. Resetting the Outdoor Control Panel will not effect the system configuration settings.

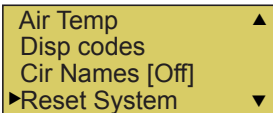

**Right button:** Press the Right button to reset system. The main screen will be displayed and communication will be established with the optional EasyTouch Indoor Control Panel if installed.

## Troubleshooting

Error Message	Possible Cause	Solution
Air Err (Displays on the Main Screen)	Air sensor not connected to the Easy-Touch motherboard.	Check that the air sensor plug is connected to J21 connector on the motherboard. Check that the sensor wire is connected properly.
Air Temperature Err (Displays in the "Diagnostics" menu)	Air sensor not connected to the Easy-Touch motherboard.	Check that the air sensor plug is connected to J21 connector on the motherboard.
Water Temperature Err (Displays in the "Diagnostics" menu)	Water sensor not connected to the EasyTouch motherboard.	Check that the water sensor plug is connected to J21 connector on the motherboard.
Solar Temperature Err (Displays in the "Diagnostics" menu)	Solar sensor not connected to the Easy-Touch motherboard.	Check that the solar sensor plug is connected to J21 connector on the motherboard.
Indoor Control Panel has no power - (screen, blank, no LEDs, buttons not working).	Bad wiring run from Outdoor Control Panel/motherboard in the Load Center.	Verify cable and ensure no connections are broken. In some cases a wire is broken under the insulation. The two center wires of the four conductor cable are suspect (Green and Yellow)
Indoor Control Panel lights up, but fails to operate correctly. The unit will not turn equipment on/off, or may turn some items on, but not off and may not LEDs near buttons on control panel.	Defective Cable/wiring	Verify cable and ensure no connections are broken. In some cases a wire is broken under the insulation. The two center wires of the four conductor cable are suspect (Green and Yellow)
iS4 fails to operate equipment.	iS4 is disabled.	See page 58 to enable the iS4.
	Defective Wiring	Verify iS4 setup. Ensure the iS4 in question has the expected circuit assignments, and is not assigned to unused circuits.
	Incorrect configuration or button setup.	See page 42 to setup the iS4 buttons.
	Defective iS4	Replace defective iS4
iS4 fails to operate only some of the switches, but others work fine.	Defective wiring on one or more iS4 leads	Verify wiring on motherboard and iS4.
	Incorrect configuration or circuit to switch assignment.	Verify motherboard connection.
SpaCommand fails to operate equipment.	SpaCommand is disabled.	See page 58 to enable the SpaCommand
	Defective Wiring	Verify SpaCommand setup. Ensure the it has the expected circuit assignments, and is not assigned to unused circuits.
	Incorrect configuration or button setup.	See page 43 to setup the SpaCommand buttons.
	Defective SpaCommand	Replace defective SpaCommand

# Troubleshooting

SpaCommand fails to operate only some of the switches, but others work fine.	Defective wiring on one or more SpaCommand leads	Verify wiring on motherboard and SpaCommand.
	Incorrect configuration or circuit to switch assignment.	Verify motherboard connection.

## Maximum Programs Exceeded

The “Maximum Programs Exceeded” message displays in the “Schedules” menu if you try to create a new program after exceeding the 12 program limit. To create a new program you must first delete an existing program. For information about deleting a program, refer to “Schedule Menu” on page 40.

## EASYTOUCH® CONTROL SYSTEMS REPLACEMENT PARTS

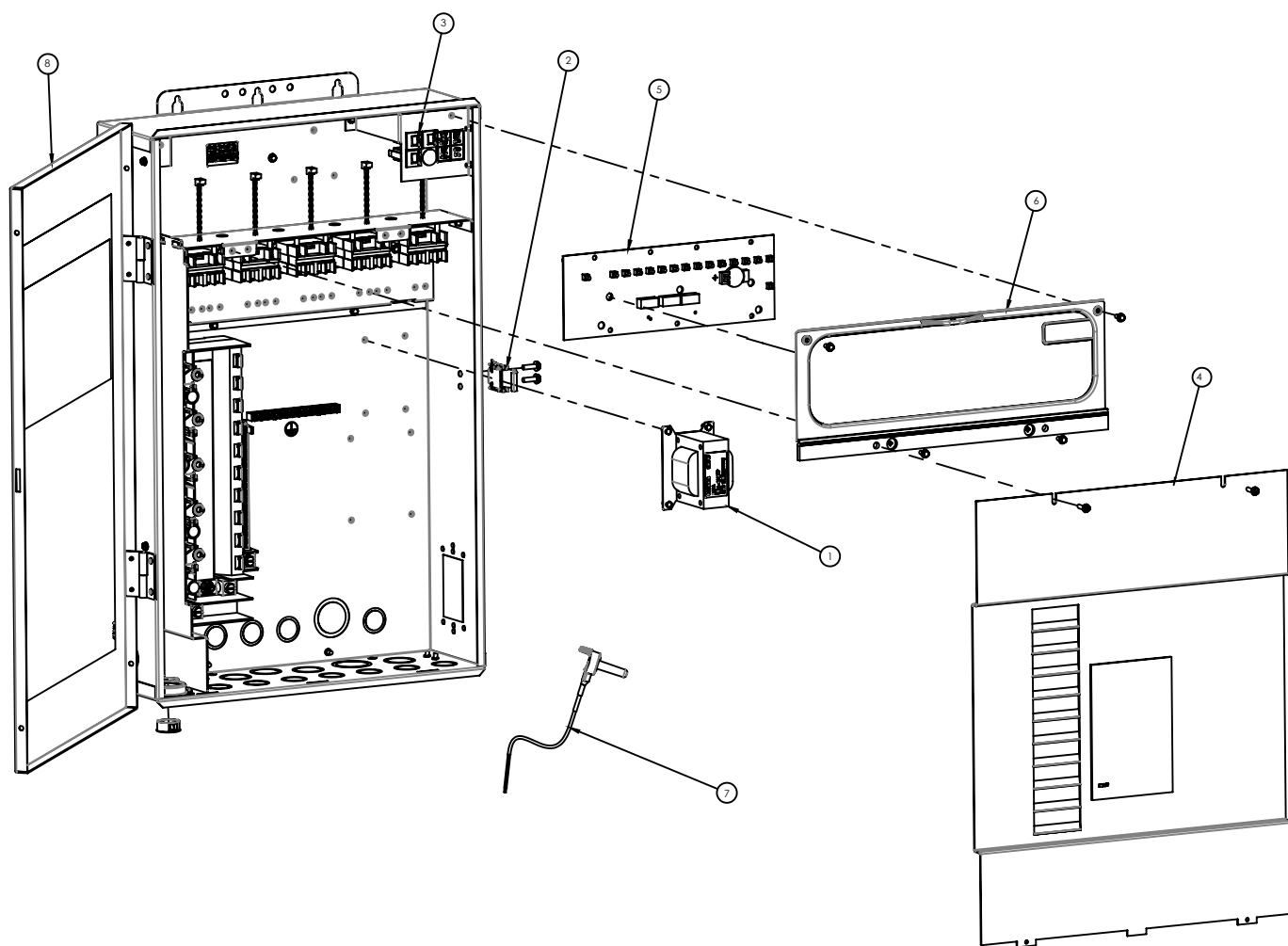

Item	Part No.	Description
NEW EASYTOUCH CONTROL SYSTEMS REPLACEMENT PARTS		
1	521233	NEW LOAD CENTER SYS XFMR
2	521081Z	KIT LC DOOR LATCH
3	8520031	REPLACEMENT CIRCUIT BREAKER
4	521051Z	NEW LOAD CENTER HIGH VOLTAGE COVER PANEL
5	520657	UOC MOTHERBOARD WITH 8 AUX (Pool & Spa)
5	520659	UOC MOTHERBOARD WITH 4 AUX (Pool & Spa)
5	520711	UOC MOTHERBOARD WITH 8 AUX (Single Body)
5	520712	UOC MOTHERBOARD WITH 4 AUX (Single Body)
6	521232	NEW LOAD CENTER OCP BEZEL
7	520272	TEMPERATURE SENSOR, 10K THERMISTOR 20 FT. FOR WATER/AIR/SOLAR
7	520872	TEMPERATURE SENSOR KIT (WATER/SOLAR + CLAMPS)
8	521227	NEW LOAD CENTER DOOR W/ET & IT LABELS
EASYTOUCH CONTROL SYSTEMS REPLACEMENT PARTS		
	520946Z	EASYTOUCH TRANSCIEVER CIRCUIT BOARD WITH ATTACHED ANTENNA
	520658	INDOOR CONTROL PANEL & WIRELESS REMOTE FEATURES LABEL (Set of 10)
	521246	QUICKTOUCH II® RECEIVER REPLC.
NOT SHOWN		
	8023302	2-PIN SCREW TERMINAL (GAS HEATER)
	8023304	4-PIN SCREW TERMINAL (COM PORT)
	8023306	6-PIN SCREW TERMINAL (iS4 & TEMPERATURE)

Item	Part No.	Description
	520108	4-PIN SCREW TERMINAL (ICP & SCREENLOGIC2)
	520283	LABEL SET OF 10 OUTDOOR CONTROL PANEL
	520658	LABEL SET OF 10 ICP AND WIRELESS CONTROL
	800759	HEX INVERTER IC's (PACK OF 3)
	520106	Relay 20A
SPA COMMAND		
	521500	REPLACEMENT PLASTICS KIT
	521502	REPLACEMENT CABLE (250FT)
	521503	SET OF LABELS (WHITE)
	521504	SET OF LABELS (BLACK)
iS4		
	522082	iS4 LABEL SET (NEW STYLE)
	520173	iS4 LABEL SET (OLD STYLE)
ACTUATORS		
	263045	VALVE ACTUATOR 180°
	520010Z	MICROSWITCH KIT

# EasyTouch®

EasyTouch® PNP 5 &  
EasyTouch® PNP 10  
Pool and Spa Control Systems



## IMPORTANT

Please attach your sales invoice/docket here as proof of purchase should warranty service be required.

Purchased from:.....

Purchase date: ..... Serial No.: ..... Model No.: .....

### Head Office Pentair AU/NZ:

1-21 Monash Drive  
Dandenong South,  
VIC 3175

---

### Australia

National customer service:	Phone:	1300 137 344
	Fax:	1800 006 688
National dealer locator:	Phone:	1800 664 266
Email:		au.sales@pentair.com
Web:		www.pentairpool.com.au

---

### New Zealand

National customer service:	Phone:	0800 654 112
	Fax:	0800 806 642
National dealer locator:	Phone:	0800 664 269
Email:		nz.sales@pentair.com
Web:		www.pentair.co.nz

---

### International Australia/New Zealand

Phone:	+61 3 9709 5800
Fax:	+61 3 9709 5888

L300274 A1016

© Information contained here-in remains the property of Pentair Australia Pty. Ltd. Any reproduction, display, publication, modification or distribution is strictly prohibited without the prior written permission of Pentair Australia Pty. Ltd.

### Disclaimer:

Every endeavour has been made to publish the correct details in this document. No responsibility will be taken for errors, omissions or changes in product descriptions, specifications. Pentair Australia reserves the right to change specifications.