

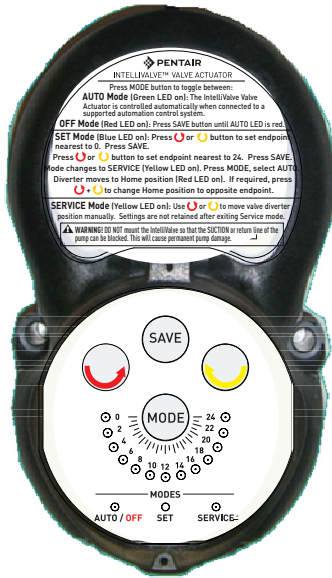

INTELLIVALVE™

2-WAY, 3-WAY VALVE ACTUATOR



INSTALLATION AND USER'S GUIDE

IMPORTANT SAFETY INSTRUCTIONS
READ AND FOLLOW ALL INSTRUCTIONS
SAVE THESE INSTRUCTIONS

CUSTOMER SERVICE / TECHNICAL SUPPORT

If you have any questions regarding this or other Pentair products, please call the following phone number:

Customer Service (8 A.M. to 7:30 P.M.)
(Eastern and Pacific Times)

Phone: (800) 831-7133

Fax: (800) 284-4151

Web site

Visit www.pentairpool.com or www.staritepool.com to find information about Pentair products.

TABLE OF CONTENTS

Important Warning and Safety	
Instructions	ii
Overview	1
Installation	2-4
Operation	5
Mode Button Functions	5
Mode Button	5
AUTO Mode	5
OFF Mode	5
Setting Home Position	6
SET Mode (Using RED/Yellow Arrow Buttons).....	6
Service Mode.....	7
Comparision to Standard valve Actuator	
Toggle Switchch.....	7
Changing Home Position	8
Example: Example: IntelliValve Valve Actuator	
on Return Valve to Split to Pool /Spa	
for Spillway Effect	9
3-Way Valve: Diverter Position vs	
IntelliValve Actuator LED position	10
2-Way Valve: Diverter Position	
vs IntelliValve Actuator LED position.....	11
3-Way Y Valve: Diverter Position	
vs IntelliValve Actuator LED position.....	12
Troubleshooting	13
Connecting Power to the IntelliValve Actuator	
(EasyTouch and IntelliTouch Control Systems)	14

IMPORTANT WARNING AND SAFETY INSTRUCTIONS



IMPORTANT NOTICE

Attention Installer: This Installation and User's Guide ("Guide") contains important information about the installation, operation and safe use of this underwater pool and spa light. This Guide should be given to the owner and/or operator of this equipment.

Attention User: This manual contains important information that will help you in operating and maintaining this product. Please retain it for future reference.

WARNING

Before installing this product, read and follow all warning notices and instructions in this Guide. Failure to follow warnings and instructions can result in severe injury, death, or property damage. Call (800) 831-7133 for additional free copies of these instructions. Please refer to www.pentairpool.com for more information related to this products.

WARNING

SERIOUS BODILY INJURY OR DEATH CAN RESULT IF THE INTELLIVALVE™ VALVE ACTUATOR IS NOT INSTALLED AND USED CORRECTLY. INSTALLERS, POOL OPERATORS AND POOL OWNERS MUST READ THESE WARNINGS AND ALL INSTRUCTIONS BEFORE INSTALLATION THE INTELLIVALVE VALVE ACTUATOR.

WARNING

This device must be installed by a licensed or certified electrician or a qualified pool professional in accordance with the National Electrical Code (NEC), NFPA 70 or the Canadian Electrical Code (CEC), CSA C22.1.

All applicable current local installation codes and ordinances must also be adhered to. Improper installation will create an electrical hazard which could result in death or serious injury to pool users, installers or others due to electrical shock, and may also cause damage to property.

Always disconnect the power at the circuit breaker before installation and servicing.

Most states and local codes regulate the construction, installation, and operation of public pools and spas, and the construction of residential pools and spas. It is important to comply with these codes, many of which directly regulate the installation and use of this product. Consult your local building and health codes for more information.

**READ AND FOLLOW ALL INSTRUCTIONS IN THIS MANUAL
SAVE THESE INSTRUCTIONS**

IntelliValve™ Valve Actuator Overview

The IntelliValve Valve Actuator is an electronically controlled motorized valve actuator which rotates the diverter valve to a set position for the desired proportion of water flow for various applications.

From the control pad the IntelliValve valve actuator provides easy setup and control of your diverter valve for pool and spa combinations, fountains, and water features. IntelliValve valve actuator supports Pentair, Compool®, Ortega® or Jandy® diverter valves and is compatible with all 24VAC control systems.

Features

- 24-Volt electronically controlled motorized valve actuator
- Easy access operator control pad for quick diverter positioning
- LEDs indicate diverter location and travel end point positions
- 46 possible set positions (approximately every 3.75 degrees) indicated by 24 diverter position LEDs.
- Retrofit for all pool/spa diverter valves
- Supports industry standard compatible diverter valves for pool/spa and pool/water feature combinations

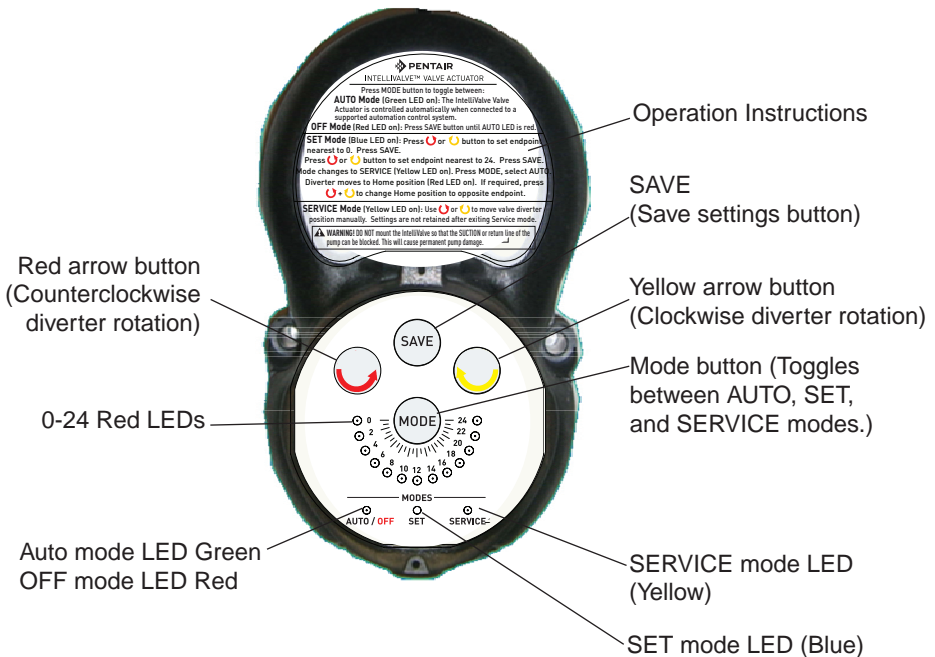

IntelliValve Valve Actuator Control Pad

INSTALLATION

Installing the IntelliValve™ Valve Actuator

The IntelliValve Valve Actuator can be installed on a 2-way, 3-way or 3-way Y valve assembly.

Note: To connect the IntelliValve valve actuator power cable to the automation control system, see pages 14 and 15.

To install the IntelliValve valve actuator (2 and 3-way valve assembly example shown):

Valve assembly without actuator:

- Unscrew and remove the diverter valve knob and handle. Remove the four (4) screws from the valve assembly top cover (embossed arrows indicate the screw locations). See Figure 1, 2 and 3.

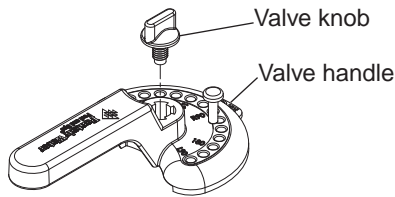

Figure 1. Diverter Handle/Knob

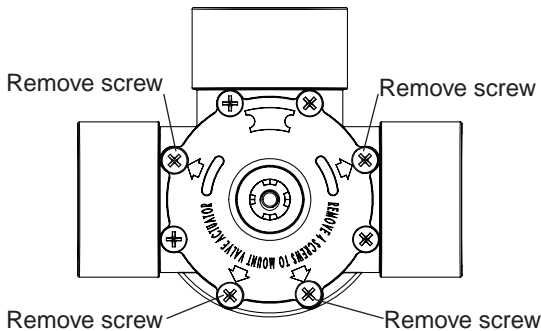

Figure 2. 3-Port Valve

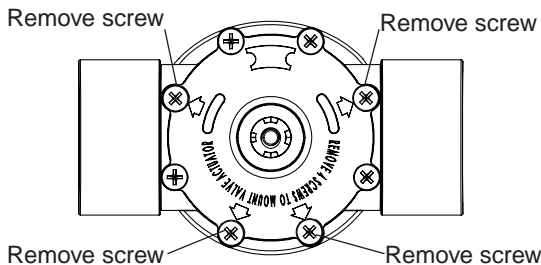

Figure 3. 2-Port Valve

Valve assembly with actuator:

1. **Caution:** Switch OFF the main system power at the circuit breakers.
2. Disconnect the valve actuator power cord from the control system.
3. Unscrew and remove the diverter valve knob and handle from the valve actuator.
4. Remove the four (4) screws from the valve actuator assembly. Remove the actuator from the valve. See Figure 4.

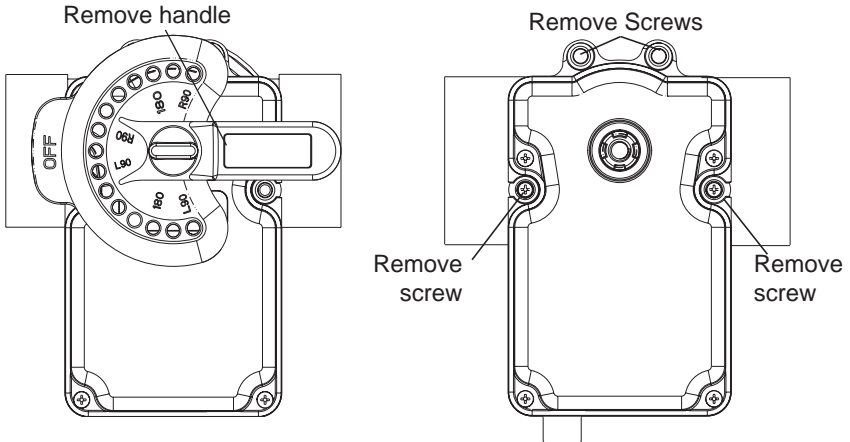
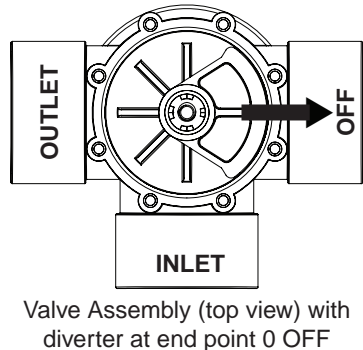
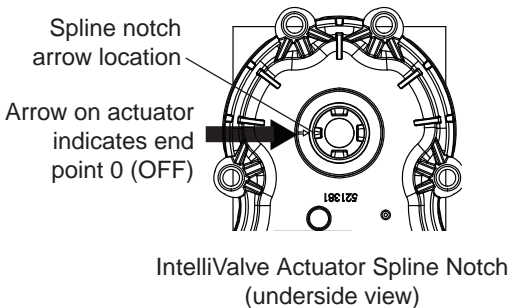

Figure 4. Valve Assembly with Actuator

Mount the IntelliValve Valve Actuator onto the Valve:

1. Align the splines of the IntelliValve valve actuator shaft over the shaft of the valve. Note: The keyed square spline notch (as shown below) indicates the position of the diverter. **Note:** End Point at 0 (OFF) is the default position of the IntelliValve valve actuator.
2. If the IntelliValve valve actuator does not align with the mounting holes on the valve cover, rotate the actuator (while still attached to the valve) until the actuator is positioned correctly over the valve.
Continue to next page.



Installing the IntelliValve™ Valve Actuator (Continued)

3. Mount the IntelliValve valve actuator onto the valve assembly and secure it with the four 2¼ inch mounting screws provided. See Figure 5 and Figure 6. **Note:** DO NOT over tighten the mounting screws.

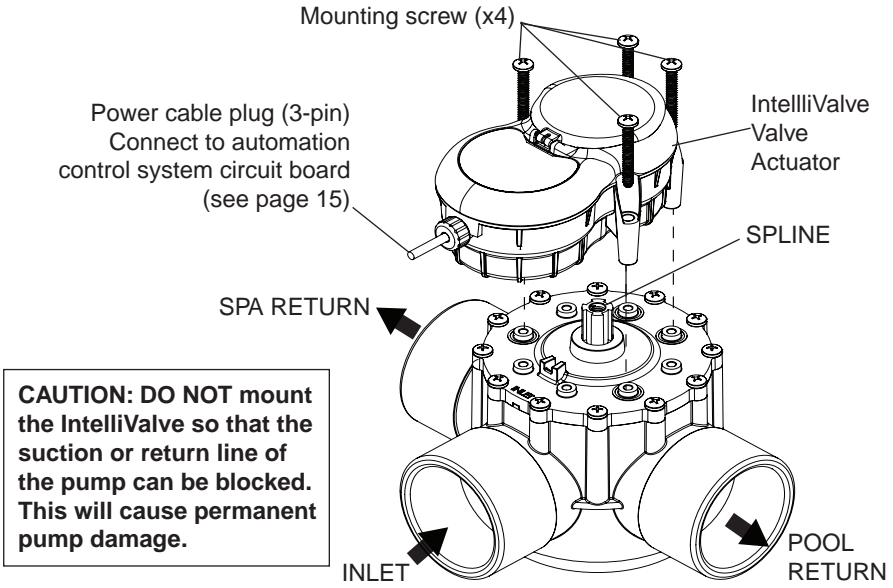

Figure 5. IntelliValve Valve Actuator Mounted on a 3-Port Valve assembly

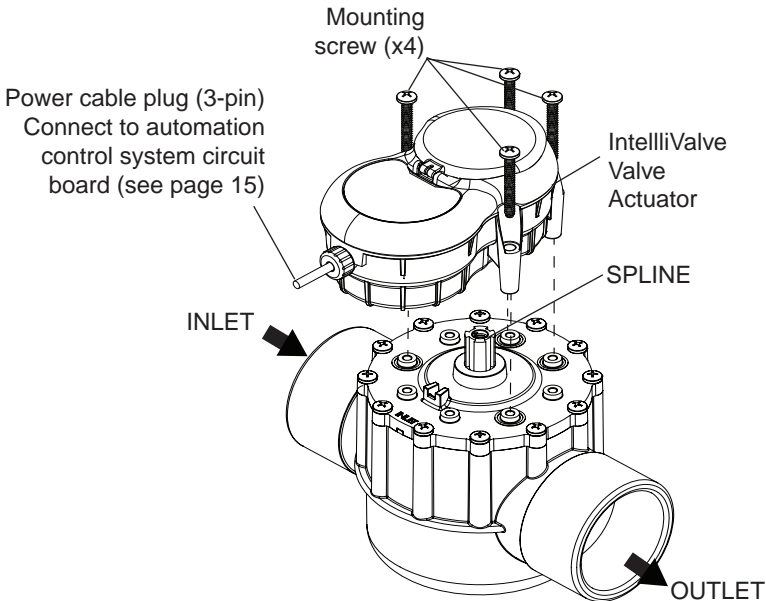

Figure 6. IntelliValve Valve Actuator Mounted on a 2-Port Valve assembly

OPERATION

IntelliValve™ Valve Actuator

The following describes the IntelliValve Valve Actuator modes of operation.

Mode Button Functions

Mode Button: Press the MODE button (press and release) to toggle between AUTO/OFF, SET and SERVICE mode.

- **AUTO** Mode (Normal Operation)
- **OFF** Mode - Disable IntelliValve Actuator function
- **SET** Mode: Set travel end points of valve diverter (see page 6)
- **SERVICE** Mode (Manual control - Temporary Settings)
(see page 7)

AUTO Mode (Green LED): The AUTO LED indicator is lit Green when the IntelliValve valve actuator is in normal operation.

- The actuator will move the diverter via the pool and spa automation control system.
- Only the current diverter position LED is lit while the diverter is in motion.
- Reversing Home Position from one end point to the other can only be done in AUTO MODE (see page 8).

OFF Mode:

- **(Red LED):** OFF mode can only be enabled while in AUTO or SERVICE mode.
- Press and hold SAVE until AUTO LED turns Red.
- All other buttons are disabled during OFF mode.
- To return to ON, press and hold SAVE again until AUTO LED turns Green.

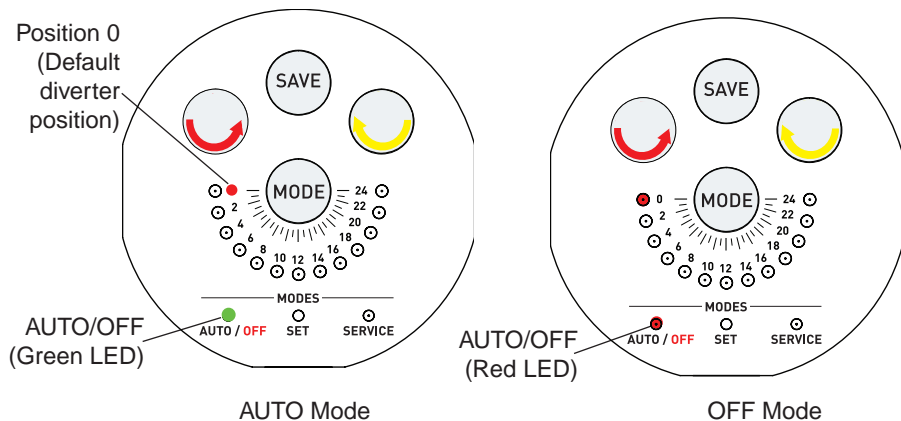

Setting Home Position

Similar to a standard actuator, the IntelliValve™ Valve Actuator factory default diverter end point positions are 0 and 24 with the “Home” position at 0. This is the diverter end point at which the diverter normally resides. Positions 0 and 24 LEDs represent the center of the diverter and are equivalent to OFF (no water flow through outlet) on a standard actuator. For examples of IntelliValve diverter positions showing the relationship between the LEDs and the diverter position see pages 10 to 13.

SET Mode (Using Red and Yellow Arrow Buttons)

The following steps describe how to change the factory default 0 and 24 position, with “0” being home position or starting from a custom home position.

To change the diverter travel end points:

1. Press MODE button until SET Blue LED is ON.
2. Press the Red arrow or Yellow arrow button to set the desired end point position of the diverter nearest 0. Press **SAVE**. The end point Red LED will flash.
3. Press the Red arrow or Yellow arrow button to set the desired end point of the diverter position nearest 24. Press **SAVE**. The end point LED diverter position (Red LED) will flash.
4. All the LEDs in the path of travel will flash five (5) times, then the LED for the last set end point will remain on.
5. The end points are now established and the MODE changes to Service (Yellow LED on).
6. Press and release the MODE button and the AUTO LED (Green) turns on and the diverter stays in or moves to the home position and the diverter location LED will remain lit (Red). The actuator can now be checked for proper operation. **Note:** Only two end point positions can be set. Setting the two end point diverter positions allows the water flow through the valve to achieve the desired effect. See example on page 10.

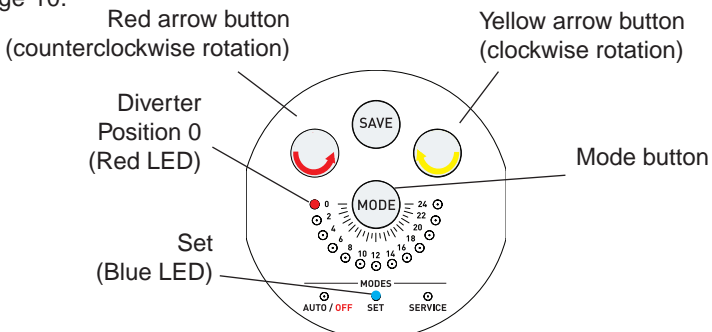

Home position 0 LED (Default Setting)

7. **Changing Home Position:** If the current diverter home position which the diverter moved to is not the desired *home* position for the application, simply press and release both the Red and Yellow arrow buttons simultaneously to move the diverter home position to the opposite end point. This is now the diverter home position. **See “Changing Home Position” on page 8.**

Service Mode

Service mode can be used for pool maintenance or service purposes. In Service mode, normal operating mode AUTO is disabled and MANUAL mode is enabled (Yellow LED on). The diverter can be moved anywhere from position 0 to 24 while in Service Mode; even if custom set endpoints were established.

Service Mode: Press MODE button until the SERVICE LED turns on (Yellow LED).

- Press the Red arrow button or Yellow arrow button to manually move the diverter to the desired position.
- Any diverter position made while in SERVICE mode is temporary.
- The actuator can be placed in OFF mode while in SERVICE mode.
- The actuator will remain in SERVICE mode until manually changed to AUTO or SET mode using the MODE button..

Exit Service Mode: To exit SERVICE mode, press the MODE button.

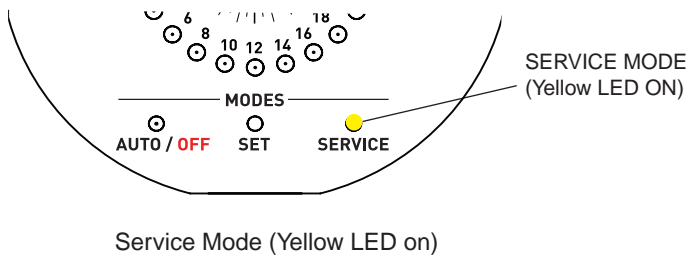

Comparison to Standard Valve Actuator Toggle Switch (ON1 - ON2)

The IntelliValve™ Valve Actuator provides the same functionality as the standard valve actuator ON1 and ON2 toggle switch.

Flipping the toggle switch on a standard valve actuator from ON1 to ON2 position is the same as reversing the “HOME” position on the IntelliValve actuator from Position 0 to Position 24.

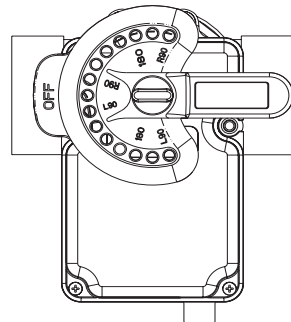

ON1 - ON2 Toggle Switch
(Standard valve actuator)

Changing Home Position

The Home position is where the diverter normally resides. While in AUTO mode the Home position can be changed to the other diverter endpoint. The factory default diverter end point positions are 0 and 24 with “0” being the “Home” position. The diverter will move between these two end points. This is similar to toggling the switch (ON1/ON2) on a standard valve actuator which causes the valve to move to the opposite endpoint.

To change the Home position: When in AUTO mode, press the **Red arrow button** and **Yellow arrow button** simultaneously. The diverter will rotate to the other end point (the new home position). The factory default home position is 0.

Changing the endpoint will move it to from Position 0 to Position 24, which changes the direction of the diverter. If custom diverter endpoint are established, it will toggle between the two established endpoints.

In the example below, the Red LED is at position 24 which now represents the current position of the valve’s internal diverter seal which is OFF (fully blocked). In this position the diverter seal restricts water flow on the left side port.

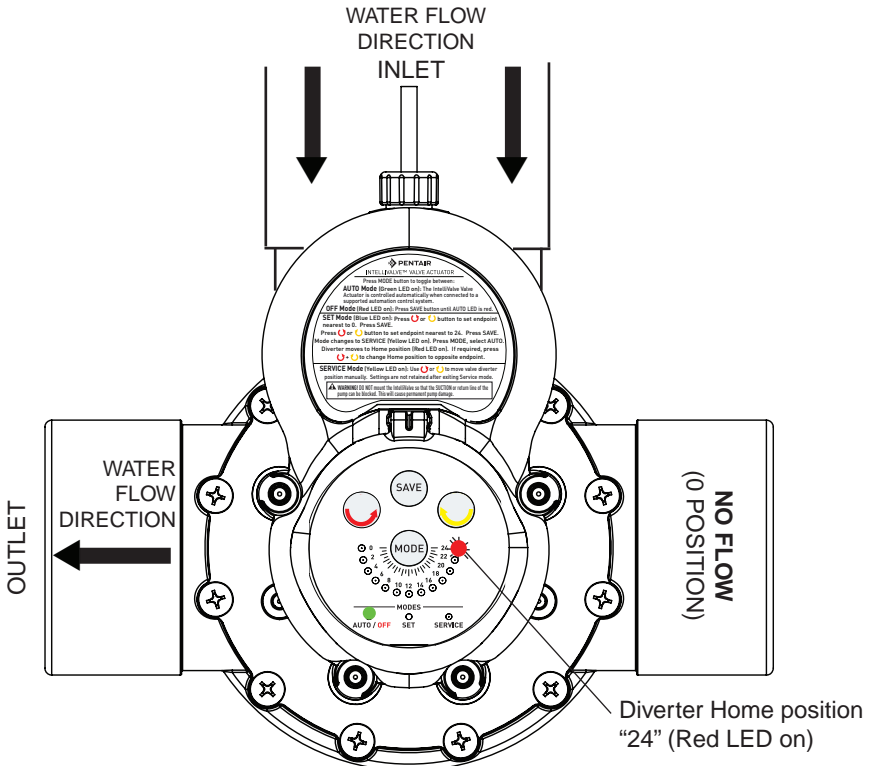

Diverter at endpoint Home Position 24 after changing the default Home position from 0 to 24 without custom endpoints established (for more information, see Step 7 on page 6)

Example: IntelliValve™ Valve Actuator on Return Valve to Split to Pool /Spa for Spillway Effect

To allow partial water flow to the spa/spillway port, set an end point position at 6. To allow complete water flow to spa/spillway set the other end point diverter position at 24. The valve actuator will now travel between positions 6 and 24 while normally residing at Home position 6.

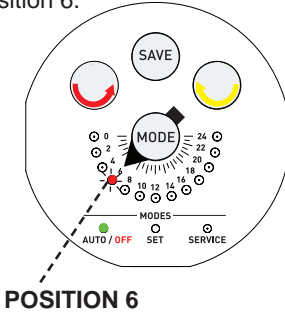

Diverter position 6 (LED on) there is partial restriction of water flow for spa/spillway.

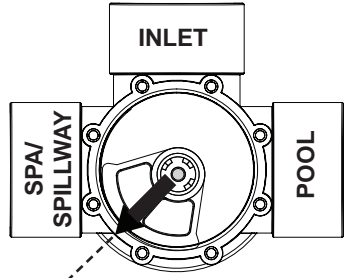

Diverter Seal at Home Position 6

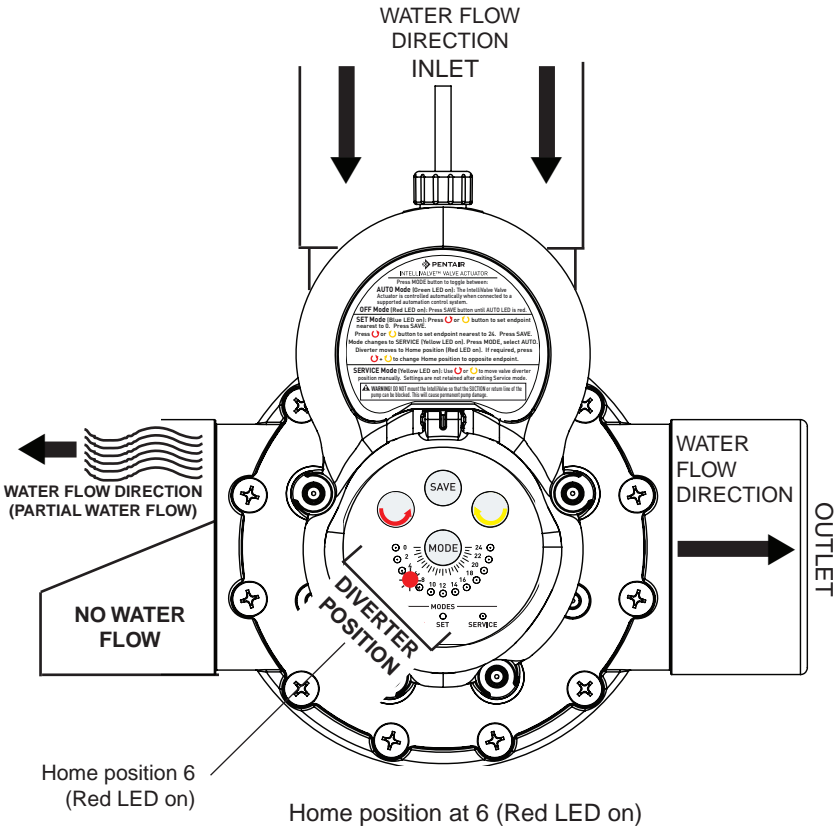

3-Way Valve: Diverter Position vs IntelliValve™ Actuator LED position

The following illustrates the relative position of the IntelliValve Actuator position LEDs and the 3-way valve diverter seal.

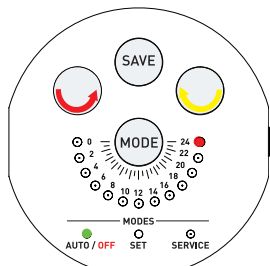

Position 24 (LED on) indicates the diverter restricts water flow for total shut off of the right side outlet.

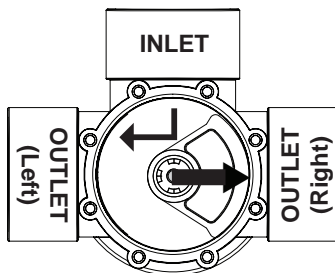

Valve diverter seal position 24

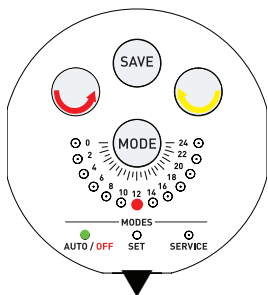

Position 12 (LED on) indicates no water flow restriction through the left and right side outlets.

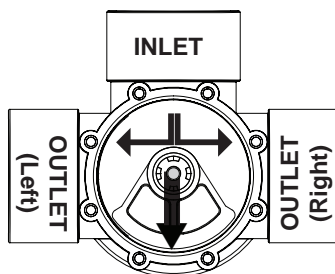

Valve diverter seal position 12

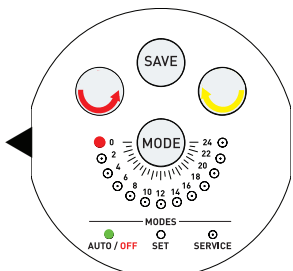

Position 0 (LED on) indicates the diverter restricts water flow for total shut off of the left side outlet.

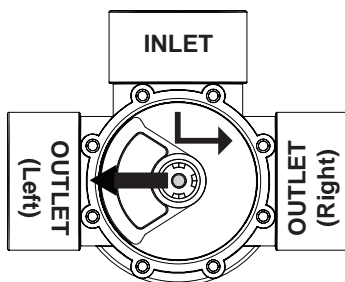

Valve diverter seal position 0

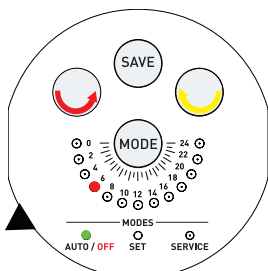

Position 6 (LED on) indicates the diverter partially restricts water flow out of the left side outlet.

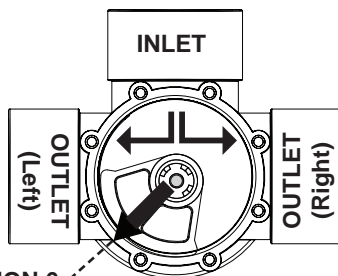

POSITION 6

Valve diverter seal position 6

3-Way Valve: Diverter Position vs IntelliValve™ Actuator LED position (Continued)

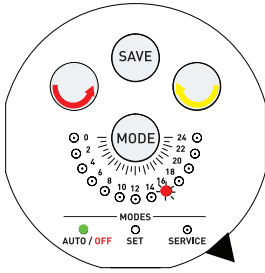

Position 16 (LED on) indicates the diverter partially restricts water flow out of the right side outlet.

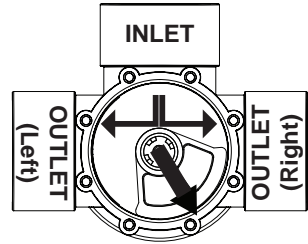

Valve diverter seal position 16

2-Way Valve: Diverter Position vs IntelliValve Actuator LED position

The following illustrates the relative position of the IntelliValve Actuator position LEDs and the 2-way valve diverter seal.

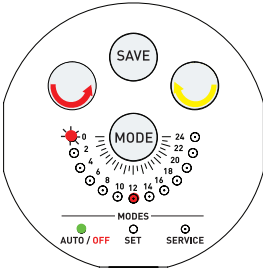

Position 0 (LED on) indicates the diverter restricts water flow for total shut off.

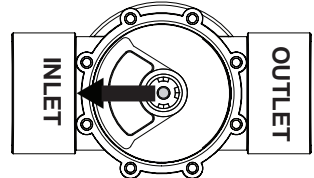

Valve diverter seal position 0

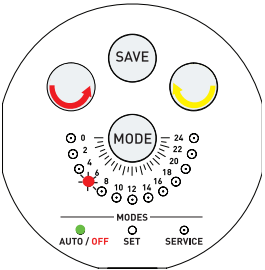

Position 6 (LED on) indicates the diverter partially restricts water flow through the valve inlet.

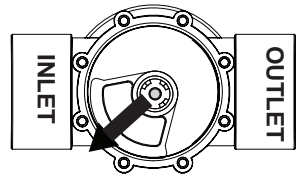

Valve diverter seal position 6

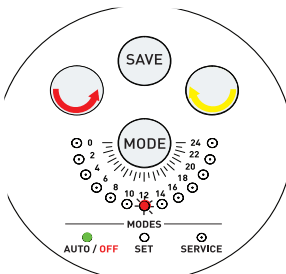

Position 12 (LED on) indicates the water flows through the valve unrestricted.

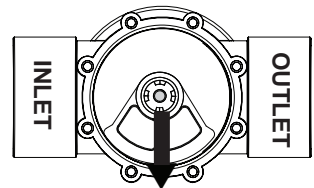

Valve diverter seal position 12

3-Way Y Valve: Diverter Position vs IntelliValve™ Actuator LED position

The following illustrates the relative position of the IntelliValve Actuator position LEDs and

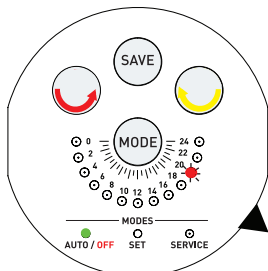

Position 20 (LED on) indicates the diverter restricts water flow for total shut off of the right side outlet.

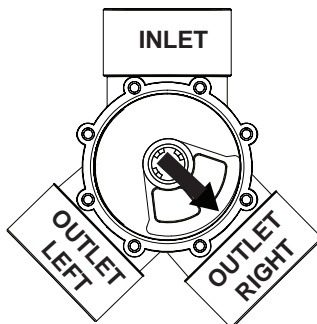

Valve diverter seal position 20

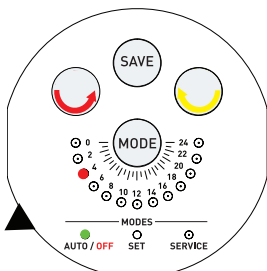

Position 4 (LED on) indicates the diverter restricts water flow for total shut off of the left side outlet.

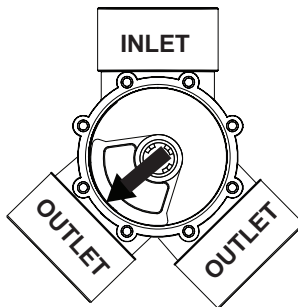

Valve diverter seal position 4

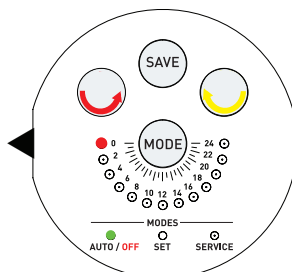

Position 0 (LED on) indicates the diverter partially restricts water flow out of the left side outlet. The water flow out of the right side outlet is unrestricted.

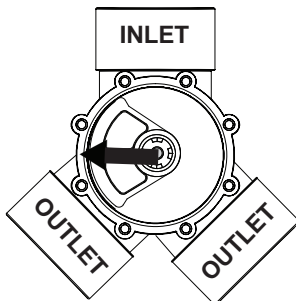

Valve diverter seal position 0

3-Way Y Valve: Diverter Position vs IntelliValve Actuator LED position (Continued)

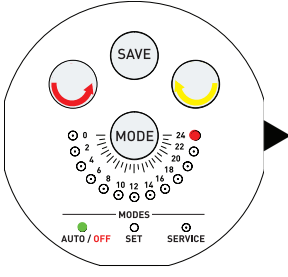

Position 24 (LED on) indicates the diverter partially restricts water flow out of the right side outlet. The water flow out of the left side outlet is unrestricted.

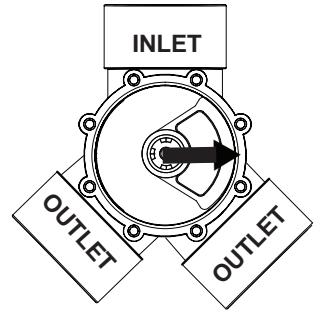

Valve diverter seal position 24

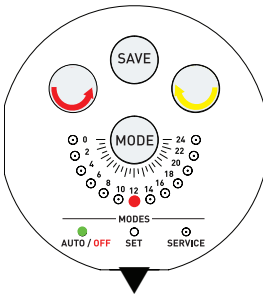

Position 12 (LED on) indicates the diverter partially restricts water flow out of the left and right side valve.

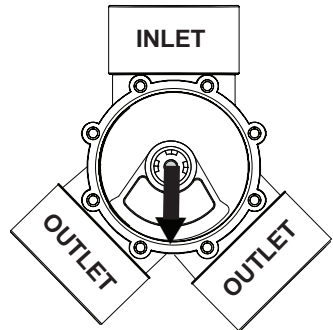

Valve diverter seal position 12

Troubleshooting

Problem:

The IntelliValve actuator did not move or went back to the previous position when the circuit was activated.

Cause:

Be sure that both end point positions are set. If not, reset both end points (see Set Mode on page 6). If only one end point diverter position was set, the actuator will revert to previous setting.

Connecting Power to the IntelliValve™ Valve Actuator (EasyTouch® and IntelliTouch® Control Systems)

After the IntelliValve valve actuator is mounted on to each of the valve assemblies, connect each IntelliValve Valve Actuator 24 V power cable to the 3-pin power sockets on the automation control system circuit board.

The EasyTouch® and IntelliTouch® Control Systems can control up to four automatic valve actuators via a RS-485 four conductor connection. Two of the standard valve outputs are dedicated to the pool/spa INTAKE and RETURN valves. Valve A or Valve B actuators are for general purpose use (solar, water-feature, in-floor cleaner, etc.).

EasyTouch Control System:



BEFORE INSTALLATION OR SERVICING THE INTELLIVALVE® VALVE ACTUATOR - Always disconnect power at the circuit breaker before servicing. Failure to do so could result in death or serious injury to service person, pool users or others due to electric shock.

NOTE: This device must be installed by a licensed or certified electrician or a qualified pool professional in accordance with the National Electrical Code (NEC), NFPA 70 or the Canadian Electrical Code (CEC), CSA C22.1.

1. At the Load Center route the 15 ft. IntelliValve actuator power cable up through the Load Center 1" grommet and low voltage raceway to the circuit board.
2. **EasyTouch Control System Circuit Board (Return and Intake Valve):** Connect the IntelliValve valve actuator power cable connector to the RETURN and/or the INTAKE (suction) 3-pin socket. If required, there are two optional valve 3-pin sockets available (Valve A and Valve B). Excess cable can be coiled in the enclosure low voltage raceway left side compartment. Do not coil the conductor in upper low voltage compartment. For valve actuator circuit board socket location see diagram below.

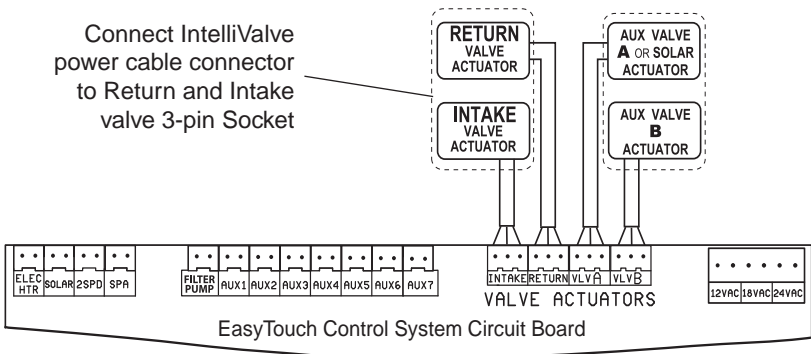

EasyTouch Control System Circuit Board

IntelliTouch® Control System:

1. IntelliTouch Control System Personality: (Intake and Return Valve):

Connect the IntelliValve valve actuator power cable connector to the INTAKE (suction) and/or RETURN 3-pin socket. If required, there are two optional valve 3-pin sockets available (Valve A and Valve B). Excess cable can be coiled in the enclosure low voltage raceway left side compartment. Do not coil the conductor in upper low voltage compartment. For valve actuator circuit board socket location see diagram below.

Note: IntelliTouch Control System Optional Valve Module Expansion Board: Using a Valve Module Expansion board (P/N 520285), three additional valve actuators (VALVE C, D and E) can be added to the system. The expansion board attaches to the edge of the IntelliTouch Personality board. For installation and operation information, refer to the IntelliTouch Valve Actuator Installation Guide (P/N 520294).

Test the IntelliValve Valve Actuators:

Switch on power to the control system at the circuit breaker and verify that the IntelliValve valve actuator are operating correctly.

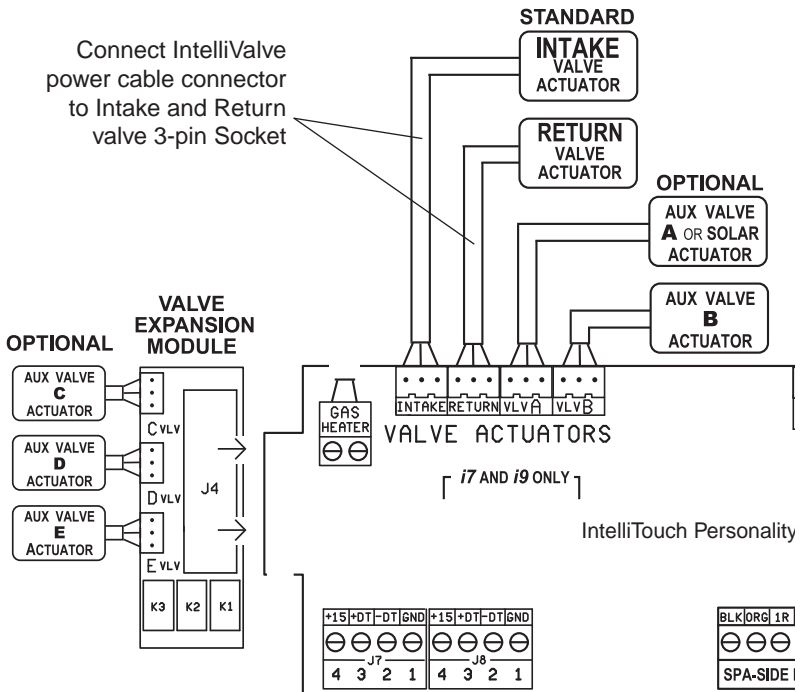

IntelliTouch Control System Circuit Board

Notes



1620 HAWKINS AVE., SANFORD, NC 27330 • (919) 566-8000
10951 WEST LOS ANGELES AVE., MOORPARK, CA 93021 • (805) 553-5000
WWW.PENTAIRPOOL.COM

All Pentair trademarks and logos are owned by Pentair or one of its global affiliates. IntelliValve™, EasyTouch®, IntelliTouch®, and SunTouch® are trademarks and/or registered trademarks of Pentair Water Pool and Spa, Inc. and/or its affiliated companies in the United States and/or other countries. Unless expressly noted, names and brands of third parties that may be used in this document are not used to indicate an affiliation or endorsement between the owners of these names and brands and Pentair Water Pool and Spa, Inc. Those names and brands may be the trademarks or registered trademarks of those third parties. Because we are continuously improving our products and services, Pentair reserves the right to change specifications without prior notice. Pentair is an equal opportunity employer.

© 2015 Pentair Aquatic Systems. All rights reserved. This document is subject to change without notice.



P/N 522301 REV. A 3/2015